

Scala®

messzeuge

## ALINOX®-Leichtbau-Messschieber A22

Die perfekte Verbindung aus Aluminium und Stahl

*ALINOX®- Light-alloy workshop callipers A22*

*The perfect combination of aluminium and stainless steel*



# Scala – Präzision seit Generationen

*Scala – Precision for generations*

Seit mehr als 75 Jahren sind Scala-Messzeuge überall dort im Einsatz, wo Genauigkeit höchste Priorität hat. Vieles hat sich in dieser Zeitspanne weiterentwickelt, auch die Fertigungstechnologien im Hause Scala. Gleich geblieben ist hingegen der Manufakturgedanke: Er kombiniert höchste Qualität mit Flexibilität und maximaler Kundenorientierung. Dadurch kann Scala seit Jahrzehnten bewährte Produkte mit hoher praxisorientierter Messgenauigkeit zu attraktiven Preisen anbieten – besonders auch bei Sonderanfertigungen.



*For more than 75 years Scala Measuring Instruments are used there, where exactness has highest priority. In these decades a lot has changed and developed in the range of products, as well as the way of the manufacturing technology. However, the idea of manufacturing increased: combining high-end quality and flexibility both to a maximum of customer's benefit. Thereby Scala was able to continue the best price-performance-ratio, even for tailor-made instruments upon drawing.*

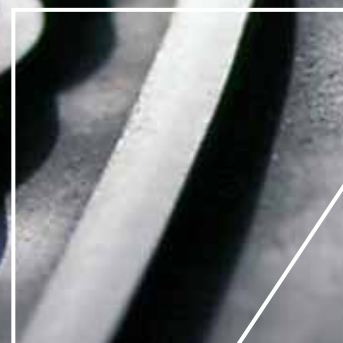

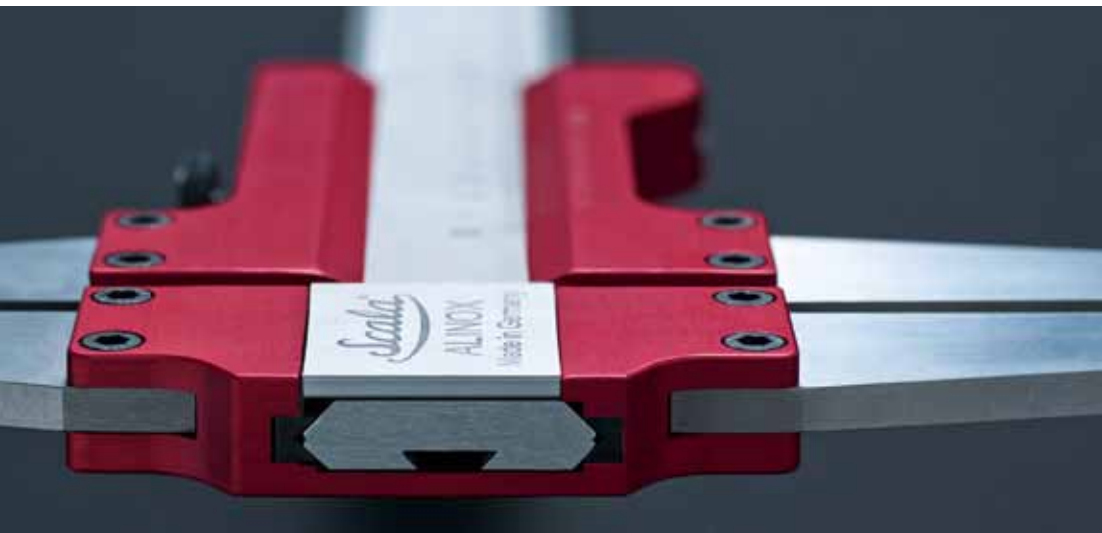

## Die neue Leichtigkeit des Messens

*The new ease of taking measure*

Die Suche nach immer besseren Lösungen hat Tradition bei Scala. Dabei ist neben der Genauigkeit immer auch die Nutzerfreundlichkeit der Messzeuge im Blick.

So meisterten die Scala-Ingenieure die Herausforderung präziser Messschieber mit sehr großen Messbereichen durch den intelligenten Einsatz von Aluminium. Das genaue Messen wurde damit im wahrsten Sinne des Wortes leichter – und die ALINOX®-Serie war geboren.

Weiteres Plus: Auch Sonderanfertigungen sind damit kostengünstig und kurzfristig realisierbar.

*The search for an always better solution is a tradition at Scala. Beside the precision the focus is set on the user's friendliness. Thus the Scala engineers mastered the challenge of producing precise callipers by the intelligent inventory of aluminium and inoxidable steel. Though the ALINOX® brand name for light-alloy callipers was born. Additional benefit: Short production periods for standard and tailormade executions.*

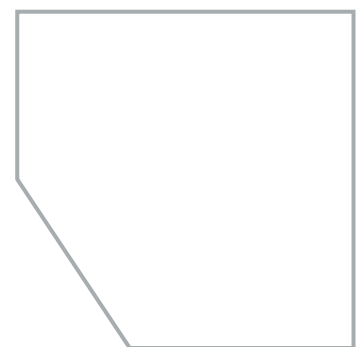
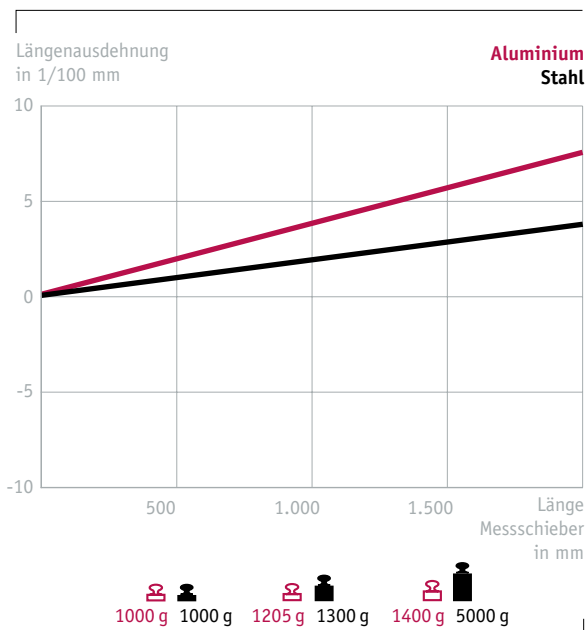

ALINOX® steht für eine Kombinationsbauweise aus ALuminium und INOXidablem Stahl. Messschnäbel aus rostfrei-gehärtetem Stahl sind präzise eingepasst und hochfest mit den Komponenten aus Aluminium verbunden. Der Schieber entsteht in Monoblock-Bauweise aus einem Stück, der Maßstab aus einem gezogenen Präzisionsprofil. Gelaserte Skalen garantieren beste Ablesbarkeit und die Prismenführung auf abriebfesten Kunststoff-Gleitflächen sorgt für leichte, spielfreie Einstellbarkeit.

*ALINOX® stands for a production method combining ALuminium and INOXidable steel. Measuring jaws made of stainless hardened steel are highly strength linked with the components made of aluminium. The cursor is made as a monoblock part, the beam of an extruded profile, both anodized and laser-graduated. Backlash-guided by abrasion-resistant plastic fittings.*

## ALINOX® – Zwei Metalle, perfekt kombiniert

*ALINOX® – The perfect union of two metals*

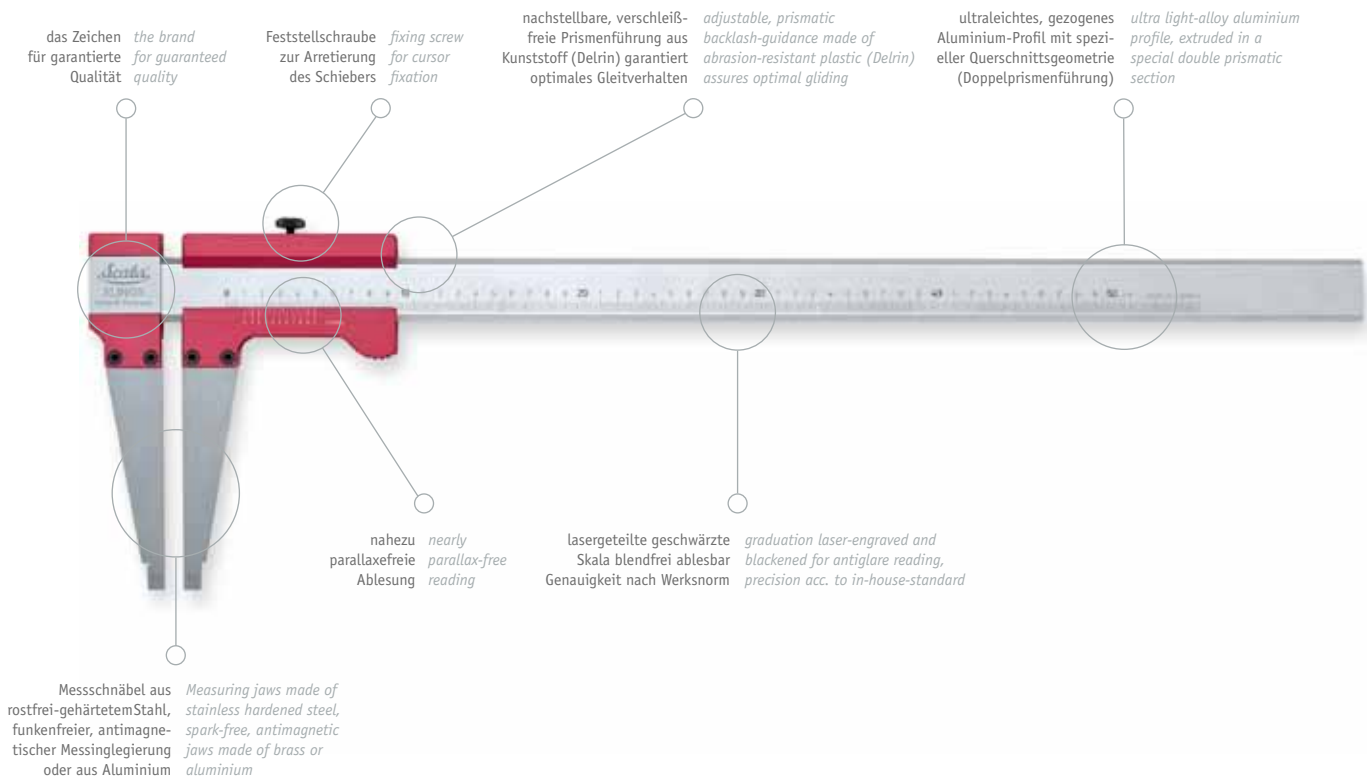

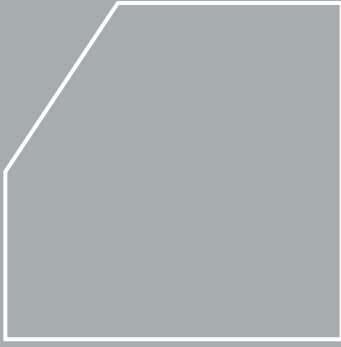

Höchste Maßstäbe bei der Materialverarbeitung sichern bei allen Messschiebern der ALINOX®-Serie Langlebigkeit und Robustheit bei hoher Messgenauigkeit.

Alle Stahlteile erhalten dabei ein hochwertiges Finish, die Oberflächen aller Aluminiumteile werden matt eloxiert und garantieren dadurch eine blendfreie Ablesung.

*A high level of quality by the material processing ensures longevity and robustness along with high measuring exactness. All steel parts receive a high-end finish, the surface of all aluminium parts are mat-anodized and allow an anti-glam reading.*

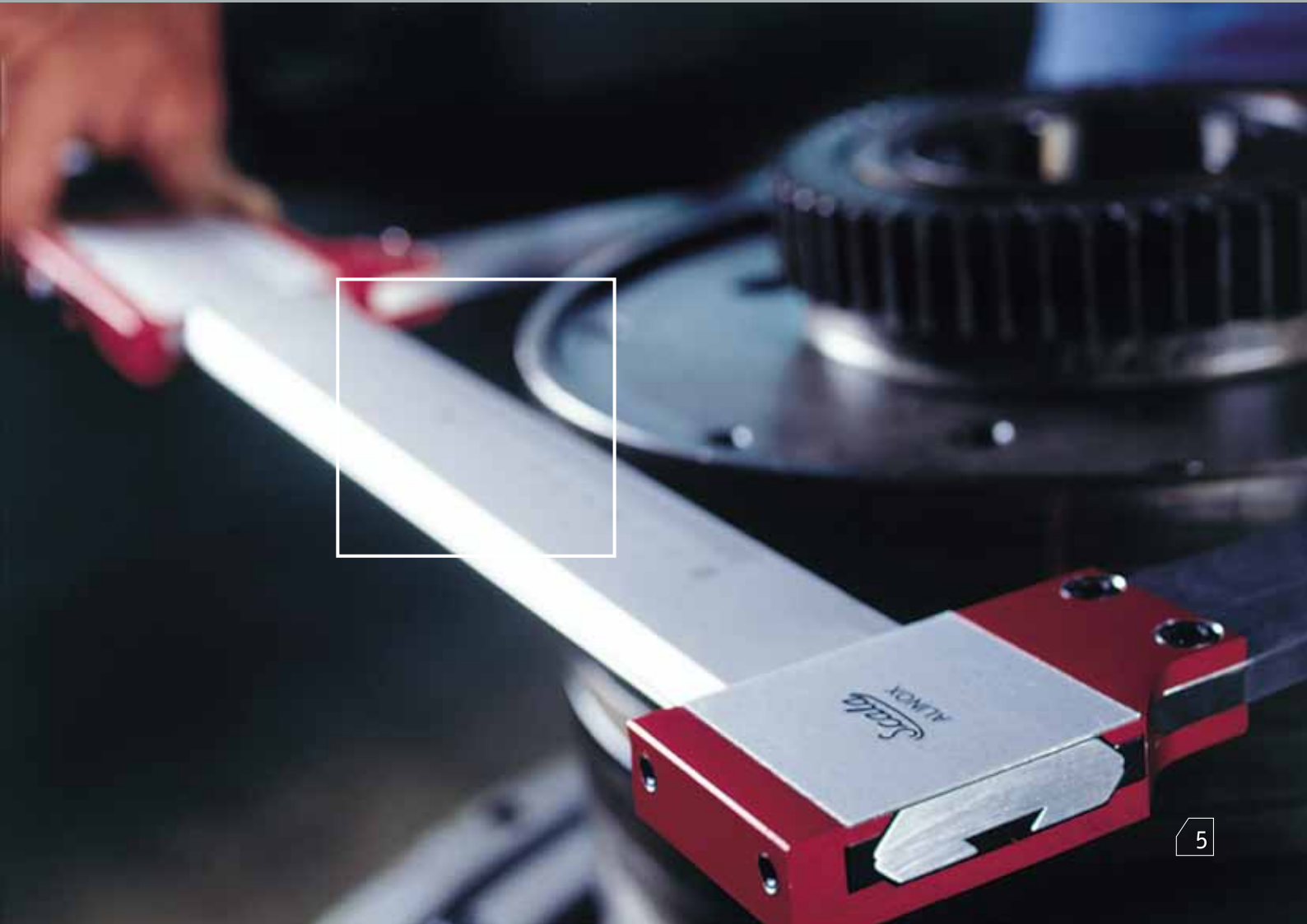

Der Messschieber ALINOX® 336 wurde speziell für den Einsatz in Werkstätten konzipiert. Aufgrund seiner Variabilität ist er optimal für den Einsatz beispielsweise in metallverarbeitenden Betrieben, im Maschinenbau oder im Möbel-, Fenster- und Türenbau geeignet.

*The ALINOX® 336 calliper became specially developed for all workshop purposes. A variety of application possibilities permits always optimal use to take measure on the field of woodworking and metalliferous handicrafts and industry.*



## Klassiker für dick und dünn

*The classic vernier calliper for almost every need*



## Spezialisten für besondere Maßnahmen

*Masters for special measures*

Weil sich viele Messaufgaben in der Praxis nicht mit herkömmlichen Messzeugen bewältigen lassen, zählen zahlreiche Sonderausführungen zum ALINOX®-Portfolio.

So wartet etwa der Bremsstrommelmessschieber mit austauschbaren Messspitzen auf. Verschiedene Streichmaße wurden speziell für den Einsatz in der Holz- und Kunststoffbearbeitung entwickelt.

*Because of many measuring tasks can't be managed with standard instruments, numerous specialized implementations bring the ALINOX® portfolio to perfect. A brake-drum calliper with interchangeable points is just one example on the automotive field. Various marking callipers were designed for plastic and woodworking purposes.*

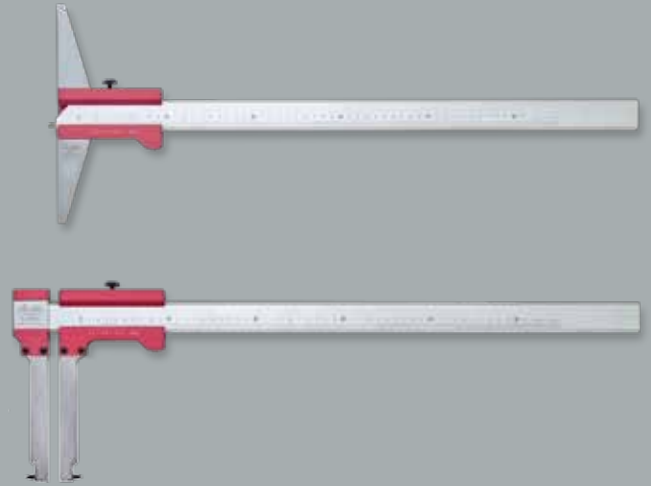
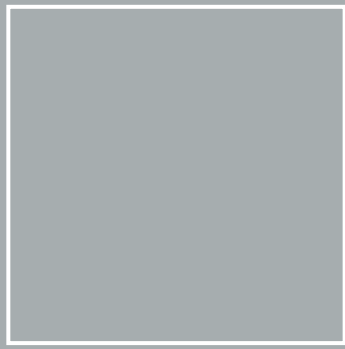

## Experten für besondere Herausforderungen

*Experts for customized challenges*

Für die Abnahme von speziellen Innen- und Aussenmaßen oder Wandstärkemessungen hält die ALINOX®-Produktpalette mehrere Varianten vor, die etwa auf Baustellen oder im Beton-, Tür- und Zargenbau benötigt werden. Ihre Qualitäten spielen sie besonders bei großen Messbereichen aus.

*The ALINOX® product range offers a variety of callipers for in- and outside measurements for the construction area. Particular where large measuring ranges and jaws are needed, these callipers highlight their specific advantages, so to measure concrete tube parts, wall and window thickness and door frames.*







Dank moderner Digitaltechnik konnte die ALINOX®-Serie um drei Modelle mit gegeneinander verschiebbaren Messschenkeln erweitert werden. Die „Duo“-Messschieber sind extrem variabel einsetzbar, da sich die Null-Position sehr einfach an jeder beliebigen Position definieren lässt.

*Thanks to modern digital technology the ALINOX® series became extended for three further models: The Alinox-Duo-Types with two movable jaws are extremely variable, as the measuring centre can be setted on a convenient working position, along with the focus of reading and weight equilibration.*

# ALINOX®-Digital

ALINOX®-Digital

Auf Wunsch liefert Scala alle ALINOX®-Modelle auch in digitaler Ausführung mit Sylvac Elektronik und optoelektronischem Datenausgang zur PC-Anbindung. Die Ablesbarkeit liegt bei 0,01 Millimetern beziehungsweise 0,0005 Zoll. Fehlergrenzen sind nach Werknorm definiert. Prüfzertifikate sind auf Anfrage erhältlich.

*Every ALINOX®-calliper is available in digital execution, equipped with Sylvac-electronic, with a reading of 0.01 mm and 0.0005 inch and optoelectronic data output for pc-connection. Calibration certificates of accredited laboratories, as well as in-house-certificates are available and will be charged extra.*



# ALINOX®-Sonderausführungen

ALINOX®- Tailormade solutions

Bei der Konzeption und Fertigung von Messschiebern nach Kundenwunsch steht bei Scala die Beratung im Vordergrund – gepaart mit Know-how und Erfahrung.

*During the conception and manufacturing of tailormade measuring instruments the customer's consultation comes first at Scala – combined with know-how and experience.*

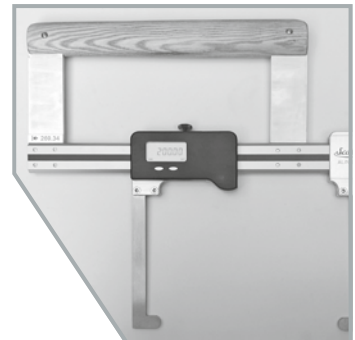
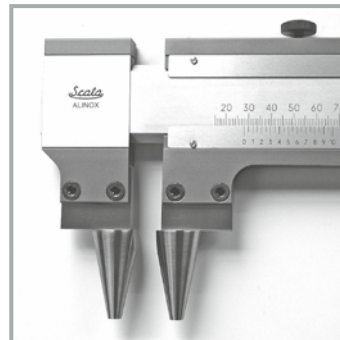
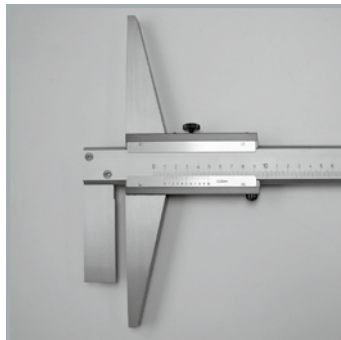
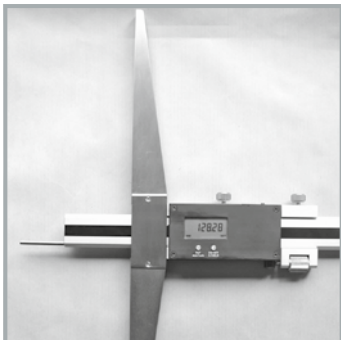
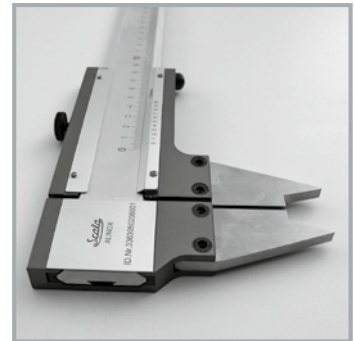
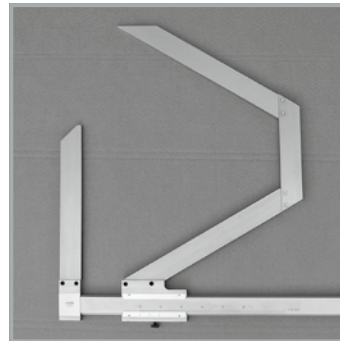
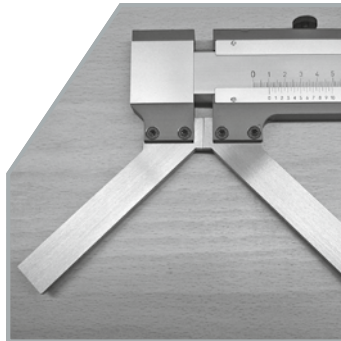
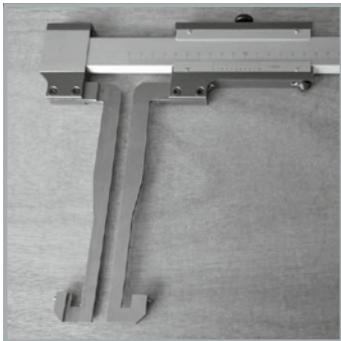
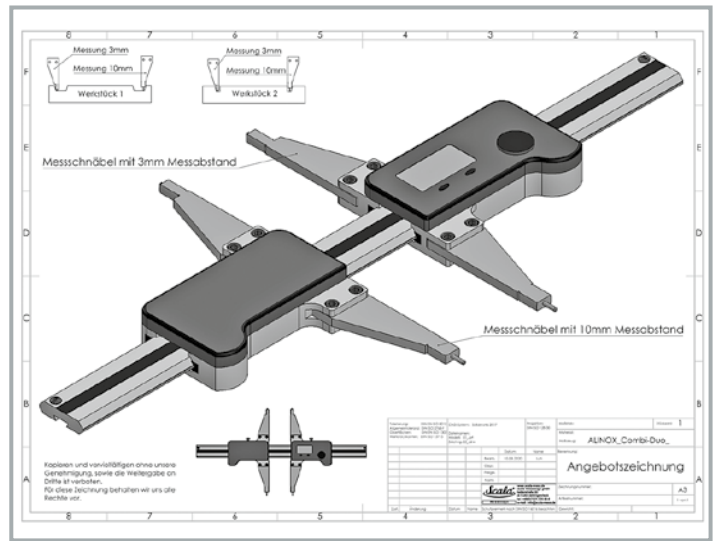
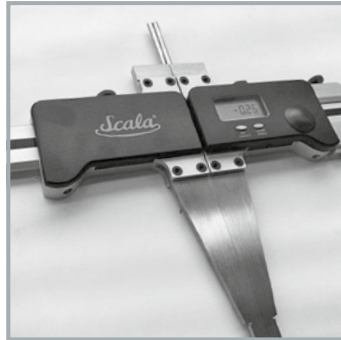

# ALINOX®-Standardausführungen

ALINOX®- The standard range

Die Standardkonfigurationen auf den folgenden Seiten decken Messbereiche zwischen 300 und 4.790 Millimetern ab. Zur Wahl stehen Messschieber-Modelle mit klassisch analoger und digitaler Ablesung, auf Wunsch auch in antimagnetischer Ausführung.

*The standard configurations on the following pages cover measuring ranges starting from 300 up to 4790 millimetres. The selection offers classic analog and digital scales, antimagnetic executions are available on request.*

# ALINOX®-Classic 336 | 338

Analoge Präzisions-Werkstattmessschieber  
Analog Precision Workshop-Callipers



ALINOX®-Classic 336 | 338



328.202

Anreiß- und Messspitzen

Marking- and measuring-points

## ALINOX®-Classic 336

Standardausführung: Schnäbel aus rostfreiem Stahl, gehärtet

*Standard type: jaws made of stainless steel, hardened*

## ALINOX®-Classic Antimag 338

Antimagnetische Ausführung:

Schnäbel aus Messing oder eloxiertem Aluminium, Schrauben aus Messing





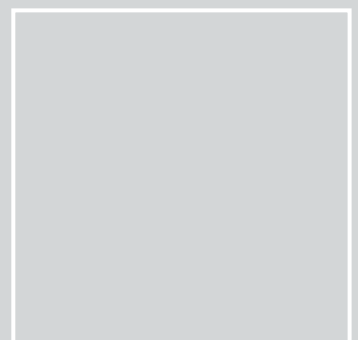

*Antimagnetic type: jaws made of brass or anodized aluminium, screws made of brass.*

- Maßstab und Schieber aus Alu-Profil
- Querschnitt des Profils 36 x 9 mm
- Nonius 1/20 mm
- mit Laserteilung, blendfreie Ablesung
- Werksnorm
- Maßeinteilung und Nonien in 1/50 mm, 1/128" und 1/1000" oder doppelte Maßteilung lieferbar (gegen Aufpreis)
- Messbereiche bis 4970 mm und Sonderanfertigungen lieferbar (Preise auf Anfrage)

- beam and cursor made of aluminium-profile
- section of beam 36 x 9 mm
- vernier 1/20 mm

- with laser-graduation, anti-glam reading
- in-house standard
- divisions and verniers in 1/50 mm, 1/128" und 1/1000" or dual graduation available (additional price)
- Measuring ranges available up to 4970 mm and special tailor-made executions upon drawing (prices on request)



		Classic	Classic Antimag				Classic	Classic Antimag	
mm	mm	Order-No.	Order-No.	Order-No.	mm	mm	Order-No.	Order-No.	Order-No.
300	125	336.560	338.560		1250	400	336.414	338.414	395.916
300	150	336.561	338.561		1250	500	336.415	338.415	395.916
300	200	336.562	338.562		1250	600	336.377	338.377	395.933
300	250	336.563	338.563		1250	700	336.378	338.378	395.933
300	300	336.564	338.564		1250	800	336.390	338.390	395.934
400	125	336.570	338.570		1500	125	336.376	338.376	395.915
400	150	336.571	338.571		1500	150	336.315	338.315	395.915
400	200	336.572	338.572		1500	200	336.371	338.371	395.915
400	250	336.573	338.573		1500	250	336.372	338.372	395.917
400	300	336.574	338.574		1500	300	336.373	338.373	395.917
400	400	336.575	338.575		1500	400	336.374	338.374	395.916
500	125	336.346	338.346	395.905	1500	500	336.375	338.375	395.916
500	150	336.305	338.305	395.905	1500	600	336.227	338.227	395.933
500	200	336.341	338.341	395.905	1500	700	336.228	338.228	395.933
500	250	336.342	338.342	395.902	1500	750	336.226	338.226	395.934
500	300	336.343	338.343	395.902	1500	800	336.229	338.229	395.934
500	400	336.344	338.344	395.901	2000	125	336.386	338.386	395.920
500	500	336.345	338.345	395.901	2000	150	336.320	338.320	395.920
500	600	336.347	338.347	395.913	2000	200	336.381	338.381	395.920
500	700	336.348	338.348	395.913	2000	250	336.382	338.382	395.922
500	800	336.349	338.349	395.914	2000	300	336.383	338.383	395.922
600	125	336.207	338.207	395.906	2000	400	336.384	338.384	395.921
600	150	336.306	338.306	395.906	2000	500	336.385	338.385	395.921
600	200	336.208	338.208	395.906	2000	600	336.387	338.387	395.935
600	250	336.209	338.209	395.903	2000	700	336.388	338.388	395.935
600	300	336.210	338.210	395.903	2000	800	336.389	338.389	395.936
600	400	336.211	338.211	395.904	2500	125	336.396	338.396	395.925
600	500	336.212	338.212	395.904	2500	150	336.325	338.325	395.925
600	600	336.217	338.217	395.918	2500	200	336.391	338.391	395.925
600	700	336.218	338.218	395.918	2500	250	336.392	338.392	395.926
600	800	336.219	338.219	395.919	2500	300	336.393	338.393	395.926
800	125	336.356	338.356	395.908	2500	400	336.394	338.394	395.927
800	150	336.308	338.308	395.908	2500	500	336.395	338.395	395.927
800	200	336.351	338.351	395.908	2500	600	336.397	338.397	395.937
800	250	336.352	338.352	395.907	2500	700	336.398	338.398	395.937
800	300	336.353	338.353	395.907	2500	800	336.399	338.399	395.938
800	400	336.354	338.354	395.909	3000	125	336.336	338.336	395.930
800	500	336.355	338.355	395.909	3000	150	336.330	338.330	395.930
800	600	336.357	338.357	395.923	3000	200	336.331	338.331	395.930
800	700	336.358	338.358	395.923	3000	250	336.332	338.332	395.931
800	800	336.359	338.359	395.924	3000	300	336.333	338.333	395.931
1000	125	336.366	338.366	395.910	3000	400	336.334	338.334	395.932
1000	150	336.310	338.310	395.910	3000	500	336.335	338.335	395.932
1000	200	336.361	338.361	395.910	3000	600	336.337	338.337	395.943
1000	250	336.362	338.362	395.912	3000	700	336.338	338.338	395.943
1000	300	336.363	338.363	395.912	3000	800	336.339	338.339	395.944
1000	400	336.364	338.364	395.911	4000	125	336.241	338.241	395.940
1000	500	336.365	338.365	395.911	4000	150	336.340	338.340	395.940
1000	600	336.367	338.367	395.928	4000	200	336.242	338.242	395.940
1000	700	336.368	338.368	395.928	4000	250	336.243	338.243	395.941
1000	800	336.369	338.369	395.929	4000	300	336.244	338.244	395.941
1200	125	336.116	338.116	395.915	4000	400	336.245	338.245	395.942
1200	150	336.312	338.312	395.915	4000	500	336.246	338.246	395.942
1200	200	336.111	338.111	395.915	4000	600	336.247	338.247	395.945
1200	250	336.112	338.112	395.917	4000	700	336.248	338.248	395.945
1200	300	336.113	338.113	395.917	4000	800	336.249	338.249	395.946
1200	400	336.114	338.114	395.916					
1200	500	336.115	338.115	395.916					
1200	600	336.317	338.317	395.933					
1200	700	336.318	338.318	395.933					
1200	800	336.319	338.319	395.934					
1250	125	336.416	338.416	395.915					
1250	150	336.313	338.313	395.915					
1250	200	336.411	338.411	395.915					
1250	250	336.412	338.412	395.917					
1250	300	336.413	338.413	395.917					



Messbereich  
Range



Schnabellänge  
Jaw length



Transportkiste aus  
Sperrholz (ab Mess-  
bereich 1000 mm oder  
Schnabellänge 500 mm  
inklusive)

Transport cases are  
made of plywood  
(from 1000 mm range  
or 500 mm jaw length  
included)

#### Zusatzleistungen Additional services

(Mehrpreis) (Additional price)	
Feineinstellung für Classic	336.370
Feineinstellung für Classic Antimag	338.370
Nonius-Sonderteilung 1/50 (0.02) mm	336.380
Reduzierter Lochmaßansatz (5 mm je Schnabel)	336.190
Rückseitige Profilverstärkung pro Meter	336.093

# ALINOX®-Point 343 | 345

Analoge Präzisions-Werkstattmessschieber mit Messerspitzen  
*Analog Precision Workshop-Callipers with knife points*



328.202

Anreiß- und Messspitzen

*Marking- and measuring-points*

## ALINOX®-Point 343

Standardausführung: Schnäbel und Spitzen aus rostfreiem Stahl, gehärtet

*Standard type: jaws and knife-points made of stainless steel, hardened*

## ALINOX®-Point Antimag 345

Antimagnetische Ausführung: Schnäbel aus Messing oder eloxiertem Aluminium, Schrauben aus Messing





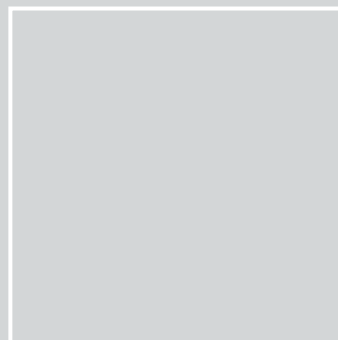

*Antimagnetic type: jaws made of brass or anodized aluminium, screws made of brass*

- Maßstab und Schieber aus Alu-Profil
- Querschnitt des Profils 36 x 9 mm
- Nonius 1/20 mm
- mit Laserteilung, blendfreie Ablesung
- Werksnorm
- Maßeinteilung und Nonien in 1/50 mm, 1/128" und 1/1000" oder doppelte Maßteilung lieferbar (gegen Aufpreis)
- Messbereiche bis 4970 mm und Sonderanfertigungen lieferbar (Preise auf Anfrage)

- *beam and cursor made of aluminium-profile*
- *section of beam 36 x 9 mm*
- *vernier 1/20 mm*

- *with laser-graduation, anti-glam reading*
- *in-house standard*
- *divisions and verniers in 1/50 mm, 1/128" and 1/1000" or dual graduation available (additional price)*
- *Measuring ranges available up to 4970 mm and special tailor-made executions upon drawing (prices on request)*



		Point	Point Antimag				Point	Point Antimag	
mm	mm	Order-No.	Order-No.	Order-No.	mm	mm	Order-No.	Order-No.	Order-No.
300	125	343.560	345.560		1250	400	343.414	345.414	395.816
300	150	343.561	345.561		1250	500	343.415	345.415	395.816
300	200	343.562	345.562		1250	600	343.377	345.377	395.833
300	250	343.563	345.563		1250	700	343.378	345.378	395.833
300	300	343.564	345.564		1250	800	343.390	345.390	395.834
400	125	343.570	345.570		1500	125	343.376	345.376	395.815
400	150	343.571	345.571		1500	150	343.315	345.315	395.815
400	200	343.572	345.572		1500	200	343.371	345.371	395.815
400	250	343.573	345.573		1500	250	343.372	345.372	395.817
400	300	343.574	345.574		1500	300	343.373	345.373	395.817
400	400	343.575	345.575		1500	400	343.374	345.374	395.816
500	125	343.346	345.346	395.805	1500	500	343.375	345.375	395.816
500	150	343.305	345.305	395.805	1500	600	343.227	345.227	395.833
500	200	343.341	345.341	395.805	1500	700	343.228	345.228	395.833
500	250	343.342	345.342	395.802	1500	750	343.226	345.226	395.834
500	300	343.343	345.343	395.802	1500	800	343.229	345.229	395.834
500	400	343.344	345.344	395.801	2000	125	343.386	345.386	395.820
500	500	343.345	345.345	395.801	2000	150	343.320	345.320	395.820
500	600	343.347	345.347	395.813	2000	200	343.381	345.381	395.820
500	700	343.348	345.348	395.813	2000	250	343.382	345.382	395.822
500	800	343.349	345.349	395.814	2000	300	343.383	345.383	395.822
600	125	343.207	345.207	395.806	2000	400	343.384	345.384	395.821
600	150	343.306	345.306	395.806	2000	500	343.385	345.385	395.821
600	200	343.208	345.208	395.806	2000	600	343.387	345.387	395.835
600	250	343.209	345.209	395.803	2000	700	343.388	345.388	395.835
600	300	343.210	345.210	395.803	2000	800	343.389	345.389	395.836
600	400	343.211	345.211	395.804	2500	125	343.396	345.396	395.825
600	500	343.212	345.212	395.804	2500	150	343.325	345.325	395.825
600	600	343.217	345.217	395.818	2500	200	343.391	345.391	395.825
600	700	343.218	345.218	395.818	2500	250	343.392	345.392	395.826
600	800	343.219	345.219	395.819	2500	300	343.393	345.393	395.826
800	125	343.356	345.356	395.808	2500	400	343.394	345.394	395.827
800	150	343.308	345.308	395.808	2500	500	343.395	345.395	395.827
800	200	343.351	345.351	395.808	2500	600	343.397	345.397	395.837
800	250	343.352	345.352	395.807	2500	700	343.398	345.398	395.837
800	300	343.353	345.353	395.807	2500	800	343.399	345.399	395.838
800	400	343.354	345.354	395.809	3000	125	343.336	345.336	395.830
800	500	343.355	345.355	395.809	3000	150	343.330	345.330	395.830
800	600	343.357	345.357	395.823	3000	200	343.331	345.331	395.830
800	700	343.358	345.358	395.823	3000	250	343.332	345.332	395.831
800	800	343.359	345.359	395.824	3000	300	343.333	345.333	395.831
1000	125	343.366	345.366	395.810	3000	400	343.334	345.334	395.832
1000	150	343.310	345.310	395.810	3000	500	343.335	345.335	395.832
1000	200	343.361	345.361	395.810	3000	600	343.337	345.337	395.843
1000	250	343.362	345.362	395.812	3000	700	343.338	345.338	395.843
1000	300	343.363	345.363	395.812	3000	800	343.339	345.339	395.844
1000	400	343.364	345.364	395.811	4000	125	343.241	345.241	395.840
1000	500	343.365	345.365	395.811	4000	150	343.340	345.340	395.840
1000	600	343.367	345.367	395.828	4000	200	343.242	345.242	395.840
1000	700	343.368	345.368	395.828	4000	250	343.243	345.243	395.841
1000	800	343.369	345.369	395.829	4000	300	343.244	345.244	395.841
1200	125	343.116	345.116	395.815	4000	400	343.245	345.245	395.842
1200	150	343.312	345.312	395.815	4000	500	343.246	345.246	395.842
1200	200	343.111	345.111	395.815	4000	600	343.247	345.247	395.845
1200	250	343.112	345.112	395.817	4000	700	343.248	345.248	395.845
1200	300	343.113	345.113	395.817	4000	800	343.249	345.249	395.846
1200	400	343.114	345.114	395.816					
1200	500	343.115	345.115	395.816					
1200	600	343.317	345.317	395.833					
1200	700	343.318	345.318	395.833					
1200	800	343.319	345.319	395.834					
1250	125	343.416	345.416	395.815					
1250	150	343.313	345.313	395.815					
1250	200	343.411	345.411	395.815					
1250	250	343.412	345.412	395.817					
1250	300	343.413	345.413	395.817					



Messbereich  
Range



Schnabellänge  
Jaw length



Transportkiste aus  
Sperrholz (ab Mess-  
bereich 1000 mm oder  
Schnabellänge 500 mm  
inklusive)

Transport cases are  
made of plywood  
(from 1000 mm range  
or 500 mm jaw length  
included)

#### Zusatzleistungen *Additional services*

(Mehrpreis) *(Additional price)*

Feineinstellung für Classic	336.370
Feineinstellung für Classic Antimag	338.370
Nonius-Sonderteilung 1/50 (0.02) mm	336.380
Reduzierter Lochmaßansatz (5 mm je Schnabel)	336.190
Rückseitige Profilverstärkung pro Meter	336.093

# ALINOX®-Digital 337 | 341

Digitale Präzisions-Werkstattmessschieber  
*Digital Precision Workshop-Callipers*



ALINOX®-Digital 337 | 341



328.202

Anreiß- und Messspitzen

*Marking- and measuring-points*

## ALINOX®-Digital 337

Schnäbel aus rostfreiem Stahl,  
gehärtet, mit Feineinstellung

*jaws made of stainless steel,  
hardened, with fine-adjustment*

## ALINOX®-Digital Antimag 341

Antimagnetische Ausführung:

Schnäbel aus Messing oder  
eloxiertem Aluminium,  
Schrauben aus Messing,  
mit Feineinstellung

*Antimagnetic type: jaws made  
of brass or anodized aluminium,  
screws made of brass,  
with fine-adjustment*

- Maßstab und Schieber aus  
Alu-Profil
- Querschnitt des Profils  
36 x 9 mm, ab 2500 mm mit  
verstärktem Profil





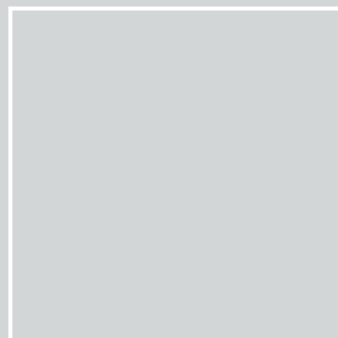

- Ablesung 0,01 mm / 0,0005"
- mit Vormaßeinstellung und  
Hold-Funktion
- Datenausgang RS 232/0pto
- Sylvac-Elektronik
- Werksnorm
- Sonderanfertigungen lieferbar  
(Preise auf Anfrage)

- *beam and cursor made of  
aluminium-profile*
- *section of beam 36 x 9 mm,  
length 2500 mm and 3000 mm  
comes with a reinforced profile*

- *reading 0.01 mm / 0.0005"*
- *pre-set-button and hold function*
- *data-output RS 232/0pto*
- *Sylvac-electronic unit*
- *in-house standard*
- *special tailormade executions  
upon drawing (prices on request)*





		Digital	Digital Antimag				Digital	Digital Antimag	
mm	mm	Order-No.	Order-No.	Order-No.	mm	mm	Order-No.	Order-No.	Order-No.
500	125	337.246	341.246	395.905	1500	125	337.276	341.276	395.915
500	150	337.205	341.205	395.905	1500	150	337.215	341.215	395.915
500	200	337.241	341.241	395.905	1500	200	337.271	341.271	395.915
500	250	337.242	341.242	395.902	1500	250	337.272	341.272	395.917
500	300	337.243	341.243	395.902	1500	300	337.273	341.273	395.917
500	400	337.244	341.244	395.901	1500	400	337.274	341.274	395.916
500	500	337.245	341.245	395.901	1500	500	337.275	341.275	395.916
500	600	337.247	341.247	395.913	1500	600	337.227	341.227	395.933
500	700	337.248	341.248	395.913	1500	700	337.228	341.228	395.933
500	800	337.249	341.249	395.914	1500	750	337.226	341.226	395.934
					1500	800	337.229	341.229	395.934
600	125	337.207	341.207	395.906	2000	125	337.286	341.286	395.920
600	150	337.206	341.206	395.906	2000	150	337.220	341.220	395.920
600	200	337.257	341.257	395.906	2000	200	337.281	341.281	395.920
600	250	337.209	341.209	395.903	2000	250	337.282	341.282	395.922
600	300	337.267	341.267	395.903	2000	300	337.283	341.283	395.922
600	400	337.211	341.211	395.904	2000	400	337.284	341.284	395.921
600	500	337.212	341.212	395.904	2000	500	337.285	341.285	395.921
600	600	337.217	341.217	395.918	2000	600	337.287	341.287	395.935
600	700	337.218	341.218	395.918	2000	700	337.288	341.288	395.935
600	800	337.219	341.219	395.919	2000	800	337.289	341.289	395.936
800	125	337.256	341.256	395.908	2500	125	337.296	341.296	395.925
800	150	337.208	341.208	395.908	2500	150	337.290	341.290	395.925
800	200	337.251	341.251	395.908	2500	200	337.291	341.291	395.925
800	250	337.252	341.252	395.907	2500	250	337.292	341.292	395.926
800	300	337.253	341.253	395.907	2500	300	337.293	341.293	395.926
800	400	337.254	341.254	395.909	2500	400	337.294	341.294	395.927
800	500	337.255	341.255	395.909	2500	500	337.295	341.295	395.927
800	600	337.260	341.260	395.923	2500	600	337.297	341.297	395.937
800	700	337.258	341.258	395.923	2500	700	337.298	341.298	395.937
800	800	337.259	341.259	395.924	2500	800	337.299	341.299	395.938
1000	125	337.266	341.266	395.910	3000	125	337.236	341.236	395.930
1000	150	337.210	341.210	395.910	3000	150	337.230	341.230	395.930
1000	200	337.261	341.261	395.910	3000	200	337.231	341.231	395.930
1000	250	337.262	341.262	395.912	3000	250	337.232	341.232	395.931
1000	300	337.263	341.263	395.912	3000	300	337.233	341.233	395.931
1000	400	337.264	341.264	395.911	3000	400	337.234	341.234	395.932
1000	500	337.265	341.265	395.911	3000	500	337.235	341.235	395.932
1000	600	337.270	341.270	395.928	3000	600	337.237	341.237	395.943
1000	700	337.268	341.268	395.928	3000	700	337.238	341.238	395.943
1000	800	337.269	341.269	395.929	3000	800	337.239	341.239	395.944
1200	125	337.116	341.116	395.915					
1200	150	337.312	341.312	395.915					
1200	200	337.111	341.111	395.915					
1200	250	337.112	341.112	395.917					
1200	300	337.113	341.113	395.917					
1200	400	337.114	341.114	395.916					
1200	500	337.115	341.115	395.916					
1200	600	337.317	341.317	395.933					
1200	700	337.318	341.318	395.933					
1200	800	337.319	341.319	395.934					
1250	125	337.126	341.126	395.915					
1250	150	337.313	341.313	395.915					
1250	200	337.121	341.121	395.915					
1250	250	337.122	341.122	395.917					
1250	300	337.123	341.123	395.917					
1250	400	337.124	341.124	395.916					
1250	500	337.125	341.125	395.916					
1250	600	337.277	341.277	395.933					
1250	700	337.278	341.278	395.933					
1250	800	337.300	341.300	395.934					



Messbereich  
Range



Schnabellänge  
Jaw length



Transportkiste aus  
Sperrholz (ab Mess-  
bereich 1000 mm oder  
Schnabellänge 500 mm  
inklusive)  
Transport cases are  
made of plywood  
(from 1000 mm range  
or 500 mm jaw length  
included)

Zusatzleistungen *Additional services*

(Mehrpreis) <i>(Additional price)</i>	
Reduzierter Lochmaßansatz (5 mm je Schnabel)	336.190
<i>Hole-size pin reduced to 5 mm each jaw</i>	
Rückseitige Profilverstärkung pro Meter *	336.093
<i>Rear reinforced profile per meter *</i>	
Schutzklasse IP66	337.902
<i>Protection class IP66</i>	
Ersatzbatterie Ø 20 mm	230.228
<i>Spare battery Ø 20 mm</i>	
Datenausgangskabel OPTO USB	337.901
<i>Data cable for pc-connection</i>	

\* ab Messbereich 2500mm inklusive  
\* starting from 2.5 mtr. included

# ALINOX®-Digital Duo 335 | 333

Digitale Präzisions-Werkstattmessschieber mit zwei beweglichen Schnäbeln  
*Digital Precision Workshop-Callipers with two movable jaws*

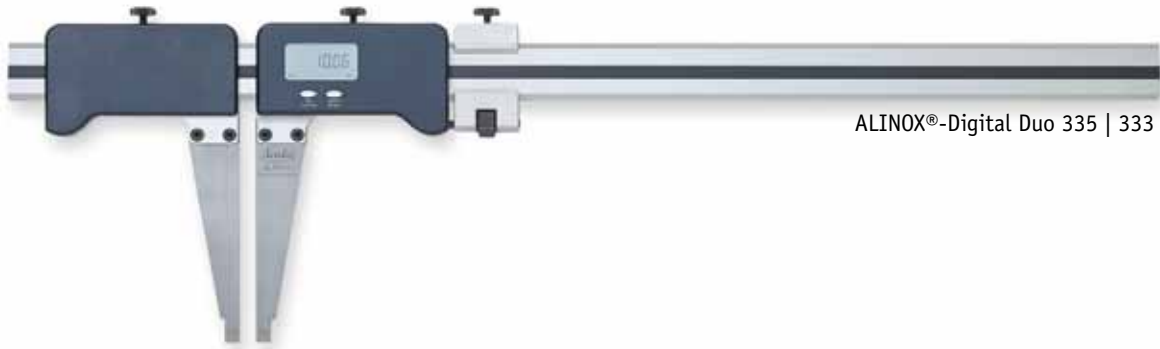

ALINOX®-Digital Duo 335 | 333



328.202

Anreiß- und Messspitzen

*Marking- and measuring-points*

## ALINOX®-Digital Duo 335

mit zwei beweglichen Mess-schnäbeln aus rostfreiem Stahl, gehärtet, mit Feineinstellung  
*with two movable jaws made of stainless steel, hardened, with fine adjustment*

## ALINOX®-Digital Duo Antimag 333

Antimagnetische Ausführung: mit zwei beweglichen Schnäbeln aus Messing oder eloxiertem Aluminium, Schrauben aus Messing, mit Feineinstellung

*Antimagnetic type:*

*with two movable jaws made of brass or anodized aluminium, screws made of brass, with fine-adjustment*

- Maßstab und Schieber aus Alu-Profil
- Querschnitt des Profils 36 x 9 mm, ab 2500 mm mit verstärktem Profil
- Ablesung 0,01 mm / 0,0005"
- mit Vormaßeinstellung und Hold-Funktion
- Datenausgang RS 232/Opto
- Sylvac-Elektronik
- Werksnorm
- Sonderanfertigungen lieferbar (Preise auf Anfrage)

- *beam and cursor made of aluminium-profile*
- *section of beam 36 x 9 mm, length 2500 mm and 3000 mm comes with a reinforced profile*

- *reading 0.01 mm / 0.0005"*
- *pre-set-button and hold function*
- *data-output RS 232/Opto*
- *Sylvac-electronic unit*
- *in-house standard*
- *special tailormade executions upon drawing (prices on request)*



Digital Duo					Digital Duo Antimag				
mm	mm	Order-No.	Order-No.	Order-No.	mm	mm	Order-No.	Order-No.	Order-No.
500	125	335.246	333.246	395.905	1500	125	335.276	333.276	395.915
500	150	335.205	333.205	395.905	1500	150	335.215	333.215	395.915
500	200	335.241	333.241	395.905	1500	200	335.271	333.271	395.915
500	250	335.242	333.242	395.902	1500	250	335.272	333.272	395.917
500	300	335.243	333.243	395.902	1500	300	335.273	333.273	395.917
500	400	335.244	333.244	395.901	1500	400	335.274	333.274	395.916
500	500	335.245	333.245	395.901	1500	500	335.275	333.275	395.916
500	600	335.247	333.247	395.913	1500	600	335.227	333.227	395.933
500	700	335.248	333.248	395.913	1500	700	335.228	333.228	395.933
500	800	335.249	333.249	395.914	1500	750	335.226	333.226	395.934
					1500	800	335.229	333.229	395.934
600	125	335.207	333.207	395.906	2000	125	335.286	333.286	395.920
600	150	335.206	333.206	395.906	2000	150	335.220	333.220	395.920
600	200	335.257	333.257	395.906	2000	200	335.281	333.281	395.920
600	250	335.209	333.209	395.903	2000	250	335.282	333.282	395.922
600	300	335.267	333.267	395.903	2000	300	335.283	333.283	395.922
600	400	335.211	333.211	395.904	2000	400	335.284	333.284	395.921
600	500	335.212	333.212	395.904	2000	500	335.285	333.285	395.921
600	600	335.217	333.217	395.918	2000	600	335.287	333.287	395.935
600	700	335.218	333.218	395.918	2000	700	335.288	333.288	395.935
600	800	335.219	333.219	395.919	2000	800	335.289	333.289	395.936
800	125	335.256	333.256	395.908	2500	125	335.296	333.296	395.925
800	150	335.208	333.208	395.908	2500	150	335.290	333.290	395.925
800	200	335.251	333.251	395.908	2500	200	335.291	333.291	395.925
800	250	335.252	333.252	395.907	2500	250	335.292	333.292	395.926
800	300	335.253	333.253	395.907	2500	300	335.293	333.293	395.926
800	400	335.254	333.254	395.909	2500	400	335.294	333.294	395.927
800	500	335.255	333.255	395.909	2500	500	335.295	333.295	395.927
800	600	335.260	333.260	395.923	2500	600	335.297	333.297	395.937
800	700	335.258	333.258	395.923	2500	700	335.298	333.298	395.937
800	800	335.259	333.259	395.924	2500	800	335.299	333.299	395.938
1000	125	335.266	333.266	395.910	3000	125	335.236	333.236	395.930
1000	150	335.210	333.210	395.910	3000	150	335.230	333.230	395.930
1000	200	335.261	333.261	395.910	3000	200	335.231	333.231	395.930
1000	250	335.262	333.262	395.912	3000	250	335.232	333.232	395.931
1000	300	335.263	333.263	395.912	3000	300	335.233	333.233	395.931
1000	400	335.264	333.264	395.911	3000	400	335.234	333.234	395.932
1000	500	335.265	333.265	395.911	3000	500	335.235	333.235	395.932
1000	600	335.270	333.270	395.928	3000	600	335.237	333.237	395.943
1000	700	335.268	333.268	395.928	3000	700	335.238	333.238	395.943
1000	800	335.269	333.269	395.929	3000	800	335.239	333.239	395.944
1200	125	335.116	333.116	395.915					
1200	150	335.312	333.312	395.915					
1200	200	335.111	333.111	395.915					
1200	250	335.112	333.112	395.917					
1200	300	335.113	333.113	395.917					
1200	400	335.114	333.114	395.916					
1200	500	335.115	333.115	395.916					
1200	600	335.317	333.317	395.933					
1200	700	335.318	333.318	395.933					
1200	800	335.319	333.319	395.934					
1250	125	335.126	333.126	395.915					
1250	150	335.313	333.313	395.915					
1250	200	335.121	333.121	395.915					
1250	250	335.122	333.122	395.917					
1250	300	335.123	333.123	395.917					
1250	400	335.124	333.124	395.916					
1250	500	335.125	333.125	395.916					
1250	600	335.277	333.277	395.933					
1250	700	335.278	333.278	395.933					
1250	800	335.300	333.300	395.934					



Messbereich  
Range



Schnabellänge  
Jaw length



Transportkiste aus  
Sperrholz (ab Mess-  
bereich 1000 mm oder  
Schnabellänge 500 mm  
inklusive)  
Transport cases are  
made of plywood  
(from 1000 mm range  
or 500 mm jaw length  
included)

Zusatzleistungen *Additional services*

(Mehrpreis) <i>(Additional price)</i>	
Reduzierter Lochmaßansatz (5 mm je Schnabel)	336.190
<i>Hole-size pin reduced to 5 mm each jaw</i>	
Rückseitige Profilverstärkung pro Meter *	336.093
<i>Rear reinforced profile per meter *</i>	
Schutzklasse IP66	337.902
<i>Protection class IP66</i>	
Ersatzbatterie Ø 20 mm	230.228
<i>Spare battery Ø 20 mm</i>	
Datenausgangskabel OPTO USB	337.901
<i>Data cable for pc-connection</i>	

\* ab Messbereich 2500mm inklusive  
\* starting from 2.5 mtr. included

# ALINOX®-Digital Duo Versal 346

Digitale Präzisions-Werkstattmessschieber für auswechselbare Messeinsätze  
Digital Precision Workshop-Callipers for interchangeable measuring pins

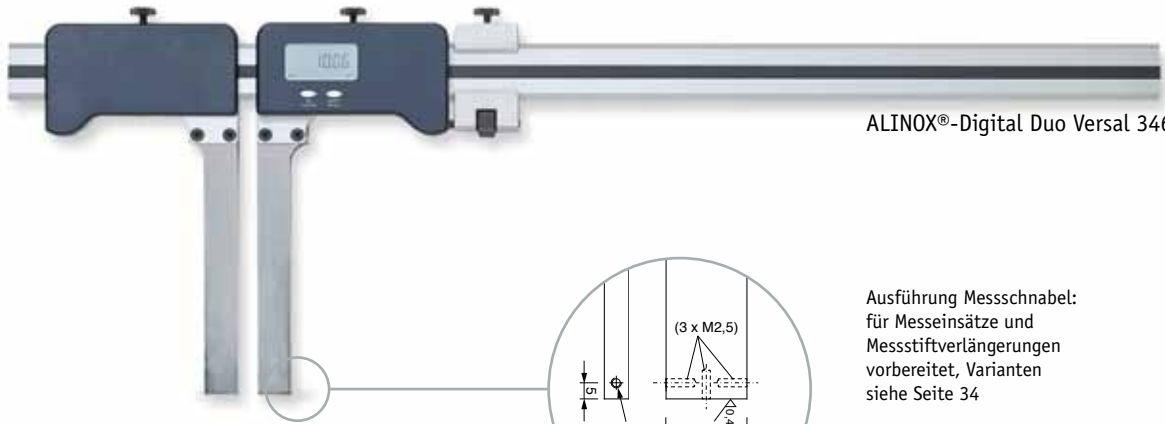

ALINOX®-Digital Duo Versal 346

Ausführung Messschnabel:  
für Messeinsätze und  
Messstiftverlängerungen  
vorbereitet, Varianten  
siehe Seite 34

*description jaw:  
for pair of pins and  
extension rods prepared,  
versions see page 34*

## ALINOX®-Digital Duo Versal 346





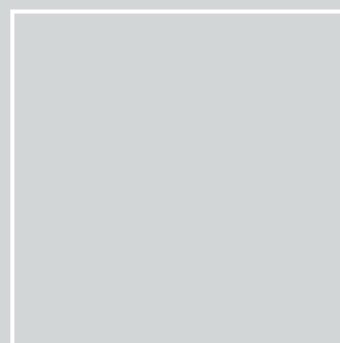

mit zwei beweglichen Messschnäbeln aus rostfreiem Stahl, gehärtet, mit senkrecht und waagrecht eingesetzten Gewindebuchsen zur Aufnahme von Messeinsätzen und Verlängerungen mit Anschlussgewinde M2,5, mit Feineinstellung  
*with two movable jaws made of stainless steel, hardened, horizontal and vertical thread inserts to adapt extensions and/or measuring pins, with fine-adjustment*

- Maßstab und Schieber aus Alu-Profil
- Querschnitt des Profils 36 x 9 mm, ab 2500 mm mit verstärktem Profil
- Ablesung 0,01 mm / 0,0005"
- mit Vormaßeinstellung und Hold-Funktion
- Datenausgang RS 232/0pto
- Sylvac-Elektronik
- Werksnorm
- Sonderanfertigungen lieferbar (Preise auf Anfrage)

- *beam and cursor made of aluminium-profile*
- *section of beam 36 x 9 mm, length 2500 mm and 3000 mm comes with a reinforced profile*

- *reading 0.01 mm / 0.0005"*
- *pre-set-button and hold function*
- *data-output RS 232/0pto*
- *Sylvac-electronic unit*
- *in-house standard*
- *special tailormade executions upon drawing (prices on request)*



  <b>Digital Duo Versal</b> 				  <b>Digital Duo Versal</b> 			
mm	mm	Order-No.	Order-No.	mm	mm	Order-No.	Order-No.
500	125	346.246	395.905	1500	125	346.276	395.915
500	150	346.205	395.905	1500	150	346.215	395.915
500	200	346.241	395.905	1500	200	346.271	395.915
500	250	346.242	395.902	1500	250	346.272	395.917
500	300	346.243	395.902	1500	300	346.273	395.917
500	400	346.244	395.901	1500	400	346.274	395.916
500	500	346.245	395.901	1500	500	346.275	395.916
500	600	346.247	395.913	1500	600	346.227	395.933
500	700	346.248	395.913	1500	700	346.228	395.933
500	800	346.249	395.914	1500	750	346.226	395.934
				1500	800	346.229	395.934
600	125	346.207	395.906	2000	125	346.286	395.920
600	150	346.206	395.906	2000	150	346.220	395.920
600	200	346.257	395.906	2000	200	346.281	395.920
600	250	346.209	395.903	2000	250	346.282	395.922
600	300	346.267	395.903	2000	300	346.283	395.922
600	400	346.211	395.904	2000	400	346.284	395.921
600	500	346.212	395.904	2000	500	346.285	395.921
600	600	346.217	395.918	2000	600	346.287	395.935
600	700	346.218	395.918	2000	700	346.288	395.935
600	800	346.219	395.919	2000	800	346.289	395.936
800	125	346.256	395.908	2500	125	346.296	395.925
800	150	346.208	395.908	2500	150	346.290	395.925
800	200	346.251	395.908	2500	200	346.291	395.925
800	250	346.252	395.907	2500	250	346.292	395.926
800	300	346.253	395.907	2500	300	346.293	395.926
800	400	346.254	395.909	2500	400	346.294	395.927
800	500	346.255	395.909	2500	500	346.295	395.927
800	600	346.260	395.923	2500	600	346.297	395.937
800	700	346.258	395.923	2500	700	346.298	395.937
800	800	346.259	395.924	2500	800	346.299	395.938
1000	125	346.266	395.910	3000	125	346.236	395.930
1000	150	346.210	395.910	3000	150	346.230	395.930
1000	200	346.261	395.910	3000	200	346.231	395.930
1000	250	346.262	395.912	3000	250	346.232	395.931
1000	300	346.263	395.912	3000	300	346.233	395.931
1000	400	346.264	395.911	3000	400	346.234	395.932
1000	500	346.265	395.911	3000	500	346.235	395.932
1000	600	346.270	395.928	3000	600	346.237	395.943
1000	700	346.268	395.928	3000	700	346.238	395.943
1000	800	346.269	395.929	3000	800	346.239	395.944
1200	125	346.116	395.915				
1200	150	346.312	395.915				
1200	200	346.111	395.915				
1200	250	346.112	395.917				
1200	300	346.113	395.917				
1200	400	346.114	395.916				
1200	500	346.115	395.916				
1200	600	346.317	395.933				
1200	700	346.318	395.933				
1200	800	346.319	395.934				
1250	125	346.126	395.915				
1250	150	346.313	395.915				
1250	200	346.121	395.915				
1250	250	346.122	395.917				
1250	300	346.123	395.917				
1250	400	346.124	395.916				
1250	500	346.125	395.916				
1250	600	346.277	395.933				
1250	700	346.278	395.933				
1250	800	346.300	395.934				

  
Messbereich  
Range

  
Schnabellänge  
Jaw length

  
Transportkiste aus  
Sperrholz (ab Mess-  
bereich 1000 mm oder  
Schnabellänge 500 mm  
inklusive)  
Transport cases are  
made of plywood  
(from 1000 mm range  
or 500 mm jaw length  
included)

#### Zusatzleistungen *Additional services*

(Mehrpreis) <i>(Additional price)</i>	
Profilverstärkung pro Meter * 336.093	
<i>Rear reinforced profile per meter *</i>	
Schutzklasse IP66 337.902	
<i>Protection class IP66</i>	
Ersatzbatterie Ø 20 mm 230.228	
<i>Spare battery Ø 20 mm</i>	
Datenausgangskabel OPTO USB 337.901	
<i>Data cable for pc-connection</i>	

\* ab Messbereich 2500mm inklusive  
\* starting from 2.5 mtr. included

#### Zubehör *accessories*

Messeinsätze (Paar) siehe Seite 34  
*Pair of pins see page 34*  
Messstiftverlängerungen (Paar) siehe Seite 34  
*Set of extension rods see page 34*

# ALINOX®-Digital Duo Groove 347

Digitale Präzisions-Werkstattmessschieber mit flach abgesetzten Schnäbeln  
Digital Precision Workshop-Callipers with flat stepped jaws

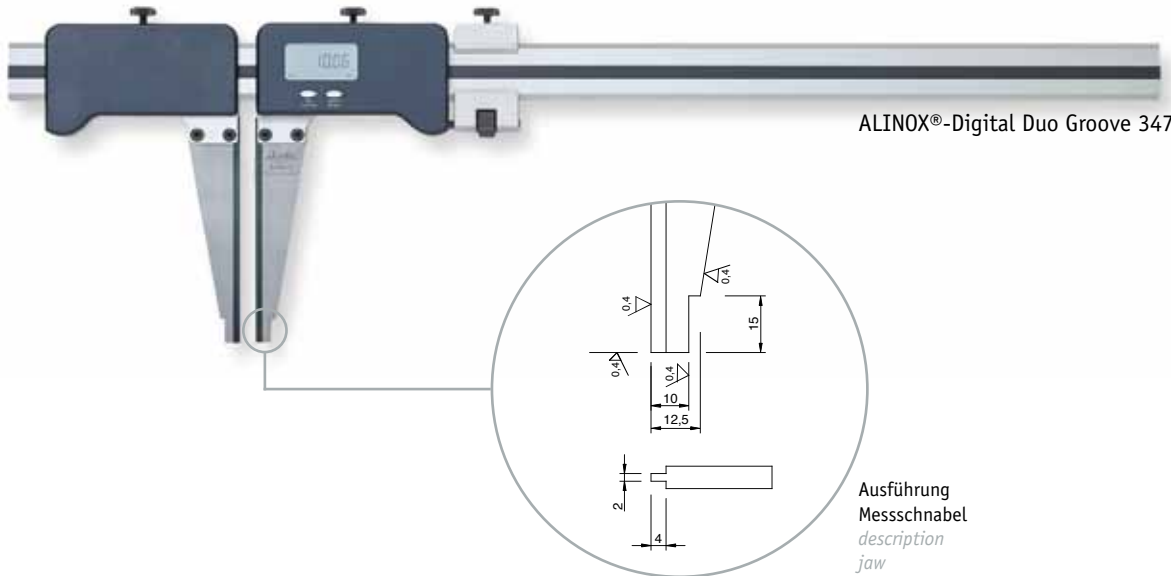

## ALINOX®-Digital Duo Groove 347



mit zwei beweglichen Messschnäbeln aus rostfreiem Stahl, gehärtet, abgesetzt auf 2 mm über die gesamte Länge der Messfläche, zur Messung von Einstichen/Außennuten, mit Feineinstellung  
*with two movable jaws made of stainless steel, hardened, with sloped jaws, stepped to 2 mm, covering the whole length of the measuring surface, to measure outside-grooves, with fine-adjustment*

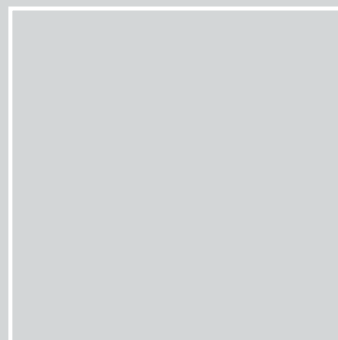

- Maßstab und Schieber aus Alu-Profil
- Querschnitt des Profils 36 x 9 mm, ab 2500 mm mit verstärktem Profil
- Ablesung 0,01 mm / 0,0005"
- mit Vormaßeinstellung und Hold-Funktion
- Datenausgang RS 232/0pto
- Sylvac-Elektronik
- Werksnorm
- Sonderanfertigungen lieferbar (Preise auf Anfrage)

- *beam and cursor made of aluminium-profile*
- *section of beam 36 x 9 mm, length 2500 mm and 3000 mm comes with a reinforced profile*

- *reading 0.01 mm / 0.0005"*
- *pre-set-button and hold function*
- *data-output RS 232/0pto*
- *Sylvac-electronic unit*
- *in-house standard*
- *special tailormade executions upon drawing (prices on request)*



				Digital Duo Groove			
mm	mm	Order-No.	Order-No.	mm	mm	Order-No.	Order-No.
500	125	347.246	395.905				
500	150	347.205	395.905				
500	200	347.241	395.905				
500	250	347.242	395.902				
500	300	347.243	395.902				
500	400	347.244	395.901				
500	500	347.245	395.901				
600	125	347.207	395.906				
600	150	347.206	395.906				
600	200	347.257	395.906				
600	250	347.209	395.903				
600	300	347.267	395.903				
600	400	347.211	395.904				
600	500	347.212	395.904				
800	125	347.256	395.908				
800	150	347.208	395.908				
800	200	347.251	395.908				
800	250	347.252	395.907				
800	300	347.253	395.907				
800	400	347.254	395.909				
800	500	347.255	395.909				
1000	125	347.266	395.910				
1000	150	347.210	395.910				
1000	200	347.261	395.910				
1000	250	347.262	395.912				
1000	300	347.263	395.912				
1000	400	347.264	395.911				
1000	500	347.265	395.911				
1200	125	347.116	395.915				
1200	150	347.312	395.915				
1200	200	347.111	395.915				
1200	250	347.112	395.917				
1200	300	347.113	395.917				
1200	400	347.114	395.916				
1200	500	347.115	395.916				
1250	125	347.126	395.915				
1250	150	347.313	395.915				
1250	200	347.121	395.915				
1250	250	347.122	395.917				
1250	300	347.123	395.917				
1250	400	347.124	395.916				
1250	500	347.125	395.916				

				Digital Duo Groove			
mm	mm	Order-No.	Order-No.	mm	mm	Order-No.	Order-No.
1500	125	347.276	395.915				
1500	150	347.215	395.915				
1500	200	347.271	395.915				
1500	250	347.272	395.917				
1500	300	347.273	395.917				
1500	400	347.274	395.916				
1500	500	347.275	395.916				
2000	125	347.286	395.920				
2000	150	347.220	395.920				
2000	200	347.281	395.920				
2000	250	347.282	395.922				
2000	300	347.283	395.922				
2000	400	347.284	395.921				
2000	500	347.285	395.921				
2500	125	347.296	395.925				
2500	150	347.290	395.925				
2500	200	347.291	395.925				
2500	250	347.292	395.926				
2500	300	347.293	395.926				
2500	400	347.294	395.927				
2500	500	347.295	395.927				
3000	125	347.236	395.930				
3000	150	347.230	395.930				
3000	200	347.231	395.930				
3000	250	347.232	395.931				
3000	300	347.233	395.931				
3000	400	347.234	395.932				
3000	500	347.235	395.932				



Messbereich  
Range



Schnabellänge  
Jaw length



Transportkiste aus  
Sperrholz (ab Mess-  
bereich 1000 mm oder  
Schnabellänge 500 mm  
inklusive)

Transport cases are  
made of plywood  
(from 1000 mm range  
or 500 mm jaw length  
included)

#### Zusatzleistungen Additional services

(Mehrpreis) (Additional price)

Profilverstärkung pro Meter \* 336.093

Rear reinforced profile per meter \*

Schutzklasse IP66 337.902

Protection class IP66

Ersatzbatterie Ø 20 mm 230.228

Spare battery Ø 20 mm

Datenausgangskabel OPTO USB 337.901

Data cable for pc-connection

\* ab Messbereich 2500 mm inklusive

\* starting from 2.5 mtr. included

# ALINOX®-Digital Duo Knife 348

Digitale Präzisions-Werkstattmessschieber mit schräg geschliffenen Schnäbeln  
Digital Precision Workshop-Callipers with sloped sharpened jaws



ALINOX®-Digital Duo Knife 348

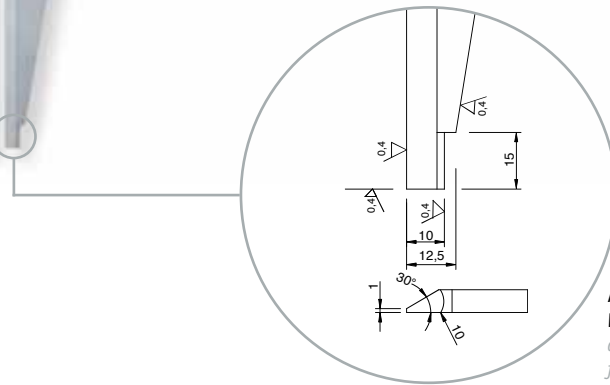

Ausführung  
Messschnabel  
description  
jaw

## ALINOX®-Digital Duo Knife 348

mit zwei beweglichen Mess-  
schnäbeln aus rostfreiem Stahl,  
gehärtet, mit schräg ange-  
schliffenen, messerförmigen  
Schnäbeln, mit Feineinstellung  
*with two movable jaws made  
of stainless steel, hardened,  
with knife-edge-sloped jaws,  
covering the whole length  
of the measuring surface,  
with fine-adjustment*





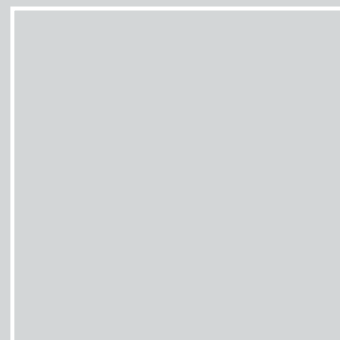

- Maßstab und Schieber aus Alu-Profil
- Querschnitt des Profils 36 x 9 mm, ab 2500 mm mit verstärktem Profil
- Ablesung 0,01 mm / 0,0005"
- mit Vormaßeinstellung und Hold-Funktion
- Datenausgang RS 232/0pto
- Sylvac-Elektronik
- Werksnorm
- Sonderanfertigungen lieferbar (Preise auf Anfrage)

- *beam and cursor made of aluminium-profile*
- *section of beam 36 x 9 mm, length 2500 mm and 3000 mm comes with a reinforced profile*

- *reading 0.01 mm / 0.0005"*
- *pre-set-button and hold function*
- *data-output RS 232/0pto*
- *Sylvac-electronic unit*
- *in-house standard*
- *special tailormade executions upon drawing (prices on request)*





  <b>Digital Duo Knife</b> 				  <b>Digital Duo Knife</b> 			
mm	mm	Order-No.	Order-No.	mm	mm	Order-No.	Order-No.
500	125	348.246	395.905	1500	125	348.276	395.915
500	150	348.205	395.905	1500	150	348.215	395.915
500	200	348.241	395.905	1500	200	348.271	395.915
500	250	348.242	395.902	1500	250	348.272	395.917
500	300	348.243	395.902	1500	300	348.273	395.917
500	400	348.244	395.901	1500	400	348.274	395.916
500	500	348.245	395.901	1500	500	348.275	395.916
500	600	348.247	395.913	1500	600	348.227	395.933
500	700	348.248	395.913	1500	700	348.228	395.933
500	800	348.249	395.914	1500	750	348.226	395.934
				1500	800	348.229	395.934
600	125	348.207	395.906	2000	125	348.286	395.920
600	150	348.206	395.906	2000	150	348.220	395.920
600	200	348.257	395.906	2000	200	348.281	395.920
600	250	348.209	395.903	2000	250	348.282	395.922
600	300	348.267	395.903	2000	300	348.283	395.922
600	400	348.211	395.904	2000	400	348.284	395.921
600	500	348.212	395.904	2000	500	348.285	395.921
600	600	348.217	395.918	2000	600	348.287	395.935
600	700	348.218	395.918	2000	700	348.288	395.935
600	800	348.219	395.919	2000	800	348.289	395.936
800	125	348.256	395.908	2500	125	348.296	395.925
800	150	348.208	395.908	2500	150	348.290	395.925
800	200	348.251	395.908	2500	200	348.291	395.925
800	250	348.252	395.907	2500	250	348.292	395.926
800	300	348.253	395.907	2500	300	348.293	395.926
800	400	348.254	395.909	2500	400	348.294	395.927
800	500	348.255	395.909	2500	500	348.295	395.927
800	600	348.260	395.923	2500	600	348.297	395.937
800	700	348.258	395.923	2500	700	348.298	395.937
800	800	348.259	395.924	2500	800	348.299	395.938
1000	125	348.266	395.910	3000	125	348.236	395.930
1000	150	348.210	395.910	3000	150	348.230	395.930
1000	200	348.261	395.910	3000	200	348.231	395.930
1000	250	348.262	395.912	3000	250	348.232	395.931
1000	300	348.263	395.912	3000	300	348.233	395.931
1000	400	348.264	395.911	3000	400	348.234	395.932
1000	500	348.265	395.911	3000	500	348.235	395.932
1000	600	348.270	395.928	3000	600	348.237	395.943
1000	700	348.268	395.928	3000	700	348.238	395.943
1000	800	348.269	395.929	3000	800	348.239	395.944
1200	125	348.116	395.915				
1200	150	348.312	395.915				
1200	200	348.111	395.915				
1200	250	348.112	395.917				
1200	300	348.113	395.917				
1200	400	348.114	395.916				
1200	500	348.115	395.916				
1200	600	348.317	395.933				
1200	700	348.318	395.933				
1200	800	348.319	395.934				
1250	125	348.126	395.915				
1250	150	348.313	395.915				
1250	200	348.121	395.915				
1250	250	348.122	395.917				
1250	300	348.123	395.917				
1250	400	348.124	395.916				
1250	500	348.125	395.916				
1250	600	348.277	395.933				
1250	700	348.278	395.933				
1250	800	348.300	395.934				



Messbereich  
Range



Schnabellänge  
Jaw length



Transportkiste aus  
Sperrholz (ab Mess-  
bereich 1000 mm oder  
Schnabellänge 500 mm  
inklusive)  
Transport cases are  
made of plywood  
(from 1000 mm range  
or 500 mm jaw length  
included)

#### Zusatzleistungen Additional services

(Mehrpreis) (Additional price)	
Profilverstärkung pro Meter *	336.093
Rear reinforced profile per meter *	
Schutzklasse IP66	337.902
Protection class IP66	
Ersatzbatterie Ø 20 mm	230.228
Spare battery Ø 20 mm	
Datenausgangskabel OPTO USB	337.901
Data cable for pc-connection	

\* ab Messbereich 2500 mm inklusive  
\* starting from 2.5 mtr. included

# ALINOX®-Combi 344 | 339

Digitale Präzisions-Werkstattmessschieber mit Messerspitzen  
*Digital Precision Workshop-Callipers with knife points*



328.202

Anreiß- und Messspitzen

*Marking- and measuring-points*

## ALINOX®-Combi 344

Schnäbel und Spitzen aus rostfreiem Stahl, gehärtet, mit Feineinstellung

*jaws and knife-points made of stainless steel, hardened, with fine-adjustment*

## ALINOX®-Combi Antimag 339

Antimagnetische Ausführung: Schnäbel und Spitzen aus Messing oder eloxiertem Aluminium, Schrauben aus Messing, mit Feineinstellung





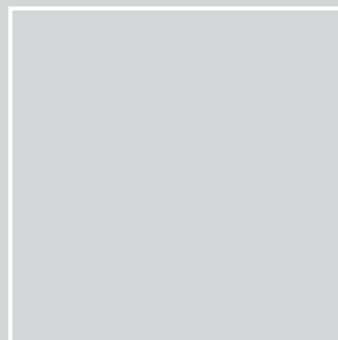

*Antimagnetic type: jaws and points made of brass or anodized aluminium, screws made of brass, with fine-adjustment*

- Maßstab und Schieber aus Alu-Profil
- Querschnitt des Profils 36 x 9 mm, ab 2500 mm mit verstärktem Profil
- Ablesung 0,01 mm / 0,0005"
- mit Vormaßeinstellung und Hold-Funktion
- Datenausgang RS 232/0pto
- Sylvac-Elektronik
- Werksnorm
- Sonderanfertigungen lieferbar (Preise auf Anfrage)

- *beam and cursor made of aluminium-profile*
- *section of beam 36 x 9 mm, length 2500 mm and 3000 mm comes with a reinforced profile*
- *reading 0.01 mm / 0.0005"*

- *pre-set-button and hold function*
- *data-output RS 232/0pto*
- *Sylvac-electronic*
- *in-house standard*
- *special tailormade executions upon drawing (prices on request)*



		Combi	Combi Antimag				Combi	Combi Antimag	
mm	mm	Order-No.	Order-No.	Order-No.	mm	mm	Order-No.	Order-No.	Order-No.
500	125	344.246	339.246	395.805	1500	125	344.276	339.276	395.815
500	150	344.205	339.205	395.805	1500	150	344.215	339.215	395.815
500	200	344.241	339.241	395.805	1500	200	344.271	339.271	395.815
500	250	344.242	339.242	395.802	1500	250	344.272	339.272	395.817
500	300	344.243	339.243	395.802	1500	300	344.273	339.273	395.817
500	400	344.244	339.244	395.801	1500	400	344.274	339.274	395.816
500	500	344.245	339.245	395.801	1500	500	344.275	339.275	395.816
500	600	344.247	339.247	395.813	1500	600	344.227	339.227	395.833
500	700	344.248	339.248	395.813	1500	700	344.228	339.228	395.833
500	800	344.249	339.249	395.814	1500	750	344.226	339.226	395.834
					1500	800	344.229	339.229	395.834
600	125	344.207	339.207	395.806	2000	125	344.286	339.286	395.820
600	150	344.206	339.206	395.806	2000	150	344.220	339.220	395.820
600	200	344.257	339.257	395.806	2000	200	344.281	339.281	395.820
600	250	344.209	339.209	395.803	2000	250	344.282	339.282	395.822
600	300	344.267	339.267	395.803	2000	300	344.283	339.283	395.822
600	400	344.211	339.211	395.804	2000	400	344.284	339.284	395.821
600	500	344.212	339.212	395.804	2000	500	344.285	339.285	395.821
600	600	344.217	339.217	395.818	2000	600	344.387	339.287	395.835
600	700	344.218	339.218	395.818	2000	700	344.388	339.288	395.835
600	800	344.219	339.219	395.819	2000	800	344.389	339.289	395.836
800	125	344.256	339.256	395.808	2500	125	344.296	339.296	395.825
800	150	344.208	339.208	395.808	2500	150	344.290	339.290	395.825
800	200	344.251	339.251	395.808	2500	200	344.291	339.291	395.825
800	250	344.252	339.252	395.807	2500	250	344.292	339.292	395.826
800	300	344.253	339.253	395.807	2500	300	344.293	339.293	395.826
800	400	344.254	339.254	395.809	2500	400	344.294	339.294	395.827
800	500	344.255	339.255	395.809	2500	500	344.295	339.295	395.827
800	600	344.260	339.260	395.823	2500	600	344.297	339.297	395.837
800	700	344.258	339.258	395.823	2500	700	344.298	339.298	395.837
800	800	344.259	339.259	395.824	2500	800	344.299	339.299	395.838
1000	125	344.266	339.266	395.810	3000	125	344.236	339.236	395.830
1000	150	344.210	339.210	395.810	3000	150	344.230	339.230	395.830
1000	200	344.261	339.261	395.810	3000	200	344.231	339.231	395.830
1000	250	344.262	339.262	395.812	3000	250	344.232	339.232	395.831
1000	300	344.263	339.263	395.812	3000	300	344.233	339.233	395.831
1000	400	344.264	339.264	395.811	3000	400	344.234	339.234	395.832
1000	500	344.265	339.265	395.811	3000	500	344.235	339.235	395.832
1000	600	344.270	339.270	395.828	3000	600	344.237	339.237	395.843
1000	700	344.268	339.268	395.828	3000	700	344.238	339.238	395.843
1000	800	344.269	339.269	395.829	3000	800	344.239	339.239	395.844
1200	125	344.116	339.116	395.815					
1200	150	344.312	339.312	395.815					
1200	200	344.111	339.111	395.815					
1200	250	344.112	339.112	395.817					
1200	300	344.113	339.113	395.817					
1200	400	344.114	339.114	395.816					
1200	500	344.115	339.115	395.816					
1200	600	344.317	339.317	395.833					
1200	700	344.318	339.318	395.833					
1200	800	344.319	339.319	395.834					
1250	125	344.126	339.126	395.815					
1250	150	344.313	339.313	395.815					
1250	200	344.121	339.121	395.815					
1250	250	344.122	339.122	395.817					
1250	300	344.123	339.123	395.817					
1250	400	344.124	339.124	395.816					
1250	500	344.125	339.125	395.816					
1250	600	344.377	339.277	395.833					
1250	700	344.378	339.278	395.833					
1250	800	344.300	339.300	395.834					



Messbereich  
Range



Schnabellänge  
Jaw length



Transportkiste aus  
Sperrholz (ab Mess-  
bereich 1000 mm oder  
Schnabellänge 500 mm  
inklusive)  
Transport cases are  
made of plywood  
(from 1000 mm range  
or 500 mm jaw length  
included)

#### Zusatzleistungen Additional services

(Mehrpreis) (Additional price)

Reduzierter Lochmaßansatz (5 mm je Schnabel) 336.190

Hole-size pin reduced to 5 mm each jaw

Rückseitige Profilverstärkung pro Meter \* 336.093

Rear reinforced profile per meter \*

Schutzklasse IP66 337.902

Protection class IP66

Ersatzbatterie Ø 20 mm 230.228

Spare battery Ø 20 mm

Datenausgangskabel OPTO USB 337.901

Data cable for pc-connection

\* ab Messbereich 2500 mm inklusive

\* starting from 2.5 mtr. included

# ALINOX®-Combi Duo 342 | 349

Digitale Präzisions-Werkstattmessschieber mit Messerspitzen  
*Digital Precision Workshop-Callipers with knife points*

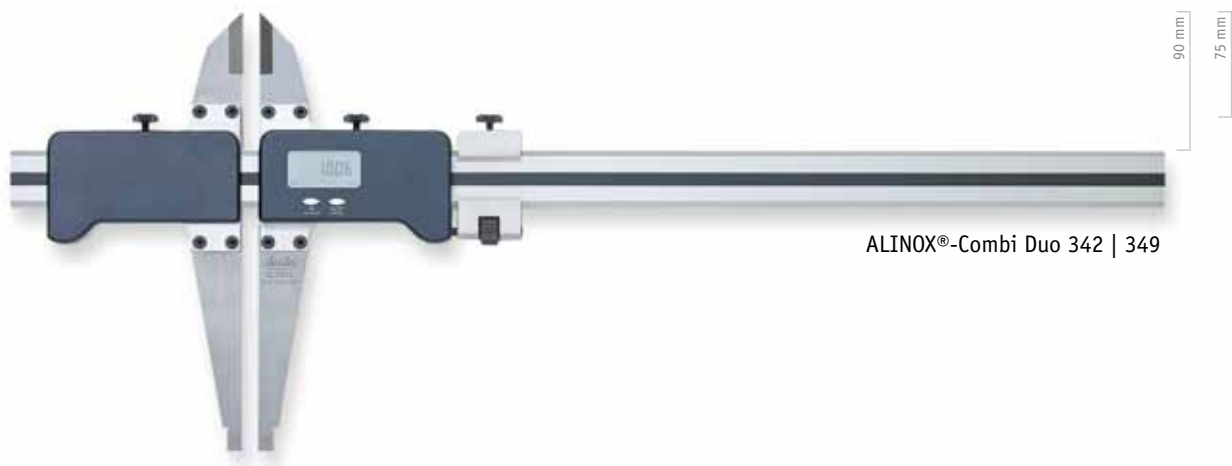

ALINOX®-Combi Duo 342 | 349



328.202

Anreiß- und Messspitzen

*Marking- and measuring-points*

## ALINOX®-Combi Duo 342

Schnäbel und Spitzen aus rostfreiem Stahl, gehärtet, mit Feineinstellung

*jaws and knife-points made of stainless steel, hardened, with fine adjustment*

## ALINOX®-Combi Duo Antimag 349

Antimagnetische Ausführung: mit zwei beweglichen Schnäbeln und Spitzen aus Messing oder eloxiertem Aluminium, Schrauben aus Messing, mit Feineinstellung

*Antimagnetic type: with two movable jaws and points made of brass or anodized aluminium, screws made of brass, with fine-adjustment*

- Maßstab und Schieber aus Alu-Profil
- Querschnitt des Profils 36 x 9 mm, ab 2500 mm mit verstärktem Profil
- Ablesung 0,01 mm / 0,0005"
- mit Vormaßeinstellung und Hold-Funktion
- Datenausgang RS 232/Opto
- Sylvac-Elektronik
- Werksnorm
- Sonderanfertigungen lieferbar (Preise auf Anfrage)

- *beam and cursor made of aluminium-profile*
- *section of beam 36 x 9 mm, length 2500 mm and 3000 mm comes with a reinforced profile*
- *reading 0.01 mm / 0.0005"*

- *pre-set-button and hold function*
- *data-output RS 232/Opto*
- *Sylvac-electronic*
- *in-house standard*
- *special tailor-made executions upon drawing (prices on request)*



Combi Duo					Combi Duo Antimag				
mm	mm	Order-No.	Order-No.	Order-No.	mm	mm	Order-No.	Order-No.	Order-No.
500	125	342.246	349.246	395.805	1500	125	342.276	349.276	395.815
500	150	342.205	349.205	395.805	1500	150	342.215	349.215	395.815
500	200	342.241	349.241	395.805	1500	200	342.271	349.271	395.815
500	250	342.242	349.242	395.802	1500	250	342.272	349.272	395.817
500	300	342.243	349.243	395.802	1500	300	342.273	349.273	395.817
500	400	342.244	349.244	395.801	1500	400	342.274	349.274	395.816
500	500	342.245	349.245	395.801	1500	500	342.275	349.275	395.816
500	600	342.247	349.247	395.813	1500	600	342.227	349.227	395.833
500	700	342.248	349.248	395.813	1500	700	342.228	349.228	395.833
500	800	342.249	349.249	395.814	1500	750	342.226	349.226	395.834
					1500	800	342.229	349.229	395.834
600	125	342.207	349.207	395.806	2000	125	342.286	349.286	395.820
600	150	342.206	349.206	395.806	2000	150	342.220	349.220	395.820
600	200	342.257	349.257	395.806	2000	200	342.281	349.281	395.820
600	250	342.209	349.209	395.803	2000	250	342.282	349.282	395.822
600	300	342.267	349.267	395.803	2000	300	342.283	349.283	395.822
600	400	342.211	349.211	395.804	2000	400	342.284	349.284	395.821
600	500	342.212	349.212	395.804	2000	500	342.285	349.285	395.821
600	600	342.217	349.217	395.818	2000	600	342.287	349.287	395.835
600	700	342.218	349.218	395.818	2000	700	342.288	349.288	395.835
600	800	342.219	349.219	395.819	2000	800	342.289	349.289	395.836
800	125	342.256	349.256	395.808	2500	125	342.296	349.296	395.825
800	150	342.208	349.208	395.808	2500	150	342.290	349.290	395.825
800	200	342.251	349.251	395.808	2500	200	342.291	349.291	395.825
800	250	342.252	349.252	395.807	2500	250	342.292	349.292	395.826
800	300	342.253	349.253	395.807	2500	300	342.293	349.293	395.826
800	400	342.254	349.254	395.809	2500	400	342.294	349.294	395.827
800	500	342.255	349.255	395.809	2500	500	342.295	349.295	395.827
800	600	342.260	349.260	395.823	2500	600	342.297	349.297	395.837
800	700	342.258	349.258	395.823	2500	700	342.298	349.298	395.837
800	800	342.259	349.259	395.824	2500	800	342.299	349.299	395.838
1000	125	342.266	349.266	395.810	3000	125	342.236	349.236	395.830
1000	150	342.210	349.210	395.810	3000	150	342.230	349.230	395.830
1000	200	342.261	349.261	395.810	3000	200	342.231	349.231	395.830
1000	250	342.262	349.262	395.812	3000	250	342.232	349.232	395.831
1000	300	342.263	349.263	395.812	3000	300	342.233	349.233	395.831
1000	400	342.264	349.264	395.811	3000	400	342.234	349.234	395.832
1000	500	342.265	349.265	395.811	3000	500	342.235	349.235	395.832
1000	600	342.270	349.270	395.828	3000	600	342.237	349.237	395.843
1000	700	342.268	349.268	395.828	3000	700	342.238	349.238	395.843
1000	800	342.269	349.269	395.829	3000	800	342.239	349.239	395.844
1200	125	342.116	349.116	395.815					
1200	150	342.312	349.312	395.815					
1200	200	342.111	349.111	395.815					
1200	250	342.112	349.112	395.817					
1200	300	342.113	349.113	395.817					
1200	400	342.114	349.114	395.816					
1200	500	342.115	349.115	395.816					
1200	600	342.317	349.317	395.833					
1200	700	342.318	349.318	395.833					
1200	800	342.319	349.319	395.834					
1250	125	342.126	349.126	395.815					
1250	150	342.313	349.313	395.815					
1250	200	342.121	349.121	395.815					
1250	250	342.122	349.122	395.817					
1250	300	342.123	349.123	395.817					
1250	400	342.124	349.124	395.816					
1250	500	342.125	349.125	395.816					
1250	600	342.277	349.277	395.833					
1250	700	342.278	349.278	395.833					
1250	800	342.300	349.300	395.834					



Messbereich  
Range



Schnabellänge  
Jaw length



Transportkiste aus  
Sperrholz (ab Mess-  
bereich 1000 mm oder  
Schnabellänge 500 mm  
inklusive)  
Transport cases are  
made of plywood  
(from 1000mm range  
or 500mm jaw length  
included)

Zusatzleistungen *Additional services*

(Mehrpreis) <i>(Additional price)</i>	
Reduzierter Lochmaßansatz (5 mm je Schnabel)	336.190
<i>Hole-size pin reduced to 5 mm each jaw</i>	
Rückseitige Profilverstärkung pro Meter *	336.093
<i>Rear reinforced profile per meter *</i>	
Schutzklasse IP66	337.902
<i>Protection class IP66</i>	
Ersatzbatterie Ø 20 mm	230.228
<i>Spare battery Ø 20 mm</i>	
Datenausgangskabel OPTO USB	337.901
<i>Data cable for pc-connection</i>	

\* ab Messbereich 2500 mm inklusive  
*\* starting from 2.5 mtr. included*

# ALINOX®-Tiefenmessschieber 353.3 | 353.2

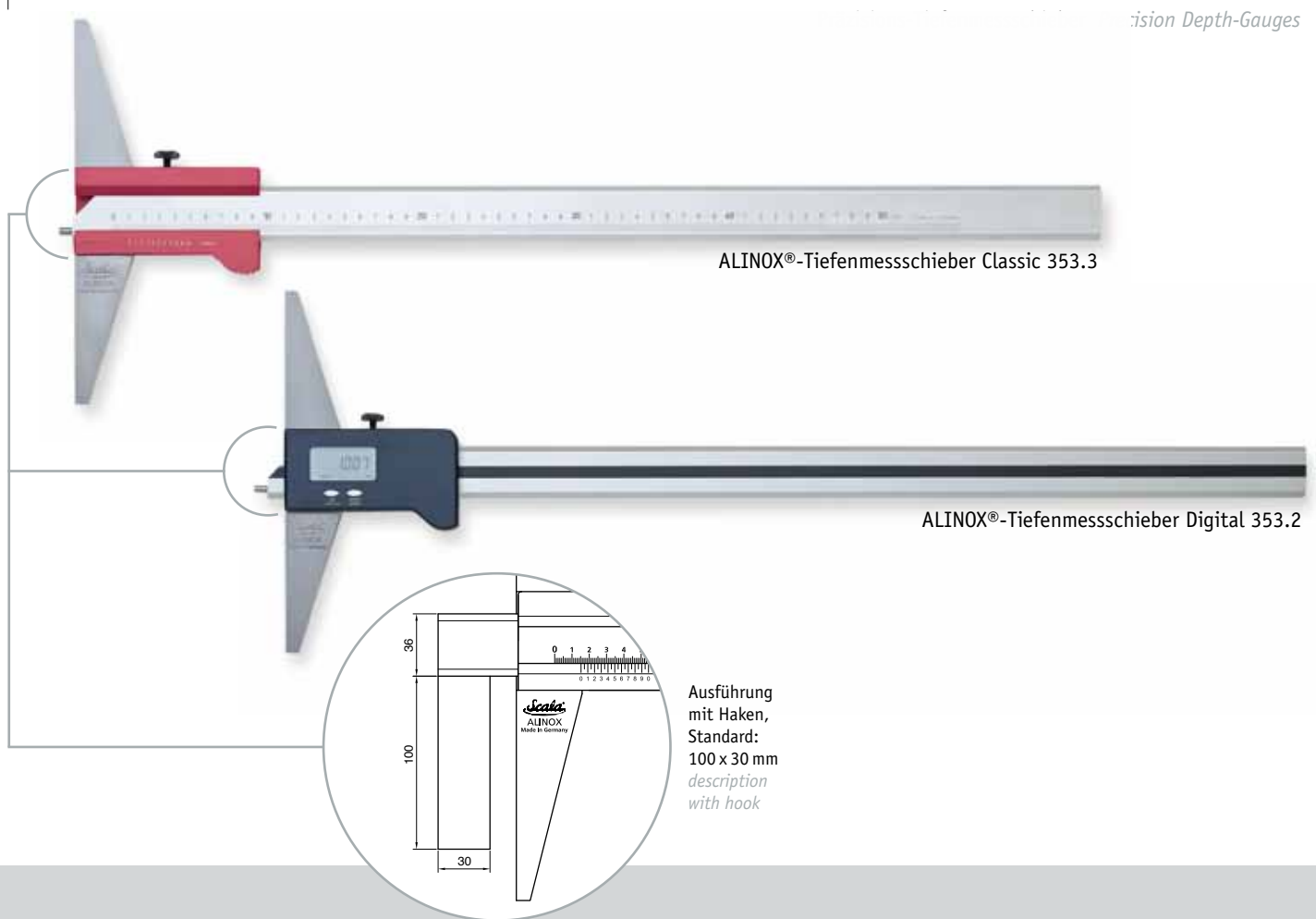

ALINOX®-Tiefenmessschieber Classic 353.3

ALINOX®-Tiefenmessschieber Digital 353.2

Ausführung  
mit Haken,  
Standard:  
100 x 30 mm  
description  
with hook

## ALINOX®-TM Classic 353.3

Nonius 1/20 mm,  
blendfreie Ablesung

vernier 1/20 mm,  
antiglare reading

- Maßstab und Schieber aus Alu-Profil
- Querschnitt des Profils 36 x 9 mm
- Nonius 1/20 mm
- mit Laserteilung, blendfreie Ablesung
- Maßseinteilung und Nonien in 1/50 mm, 1/128" und 1/1000" lieferbar (gegen Aufpreis)
- Messbrücke aus rostfreiem Stahl, gehärtet
- gehärteter Messstift
- Brücke (und Haken) erhältlich in Aluminium oder Messing und in Sondermaßen
- mit Feststellschraube
- Werksnorm

- beam and cursor made of aluminium-profile
- section of beam 36 x 9 mm
- vernier 1/20 mm
- with laser-graduation, anti-glare reading
- divisions and verniers available in 1/50 mm, 1/128" and 1/1000" (additional price)
- measuring-bridge made of stainless steel, hardened
- hardened measuring-pin
- bridges (and hawk) available in aluminium or brass and in special dimensions
- with fixing screw
- in-house standard

## ALINOX®-TM Digital 353.2

Ablesung 0.01 mm / 0.0005",  
reading 0.01 mm / 0.0005"

- Maßstab und Schieber aus Alu-Profil
- Messbrücke aus rostfreiem Stahl, gehärtet
- gehärteter Messstift
- Brücke (und Haken) erhältlich in Aluminium oder Messing und in Sondermaßen
- mit Feststellschraube
- mit Vormeaßeinstellung und Hold-Funktion
- Datenausgang RS 232/Opto
- Sylvac-Elektronik
- Werksnorm

- beam and cursor made of aluminium-profile
- measuring-bridge made of stainless steel, hardened
- hardened measuring pin
- bridges (and hawk) available in aluminium or brass and in special dimensions
- with fixing screw
- pre-set-button and hold function
- data-output RS 232/Opto
- Sylvac-Electronic
- in-house standard



Classic 353.3				Digital 353.2			
mm	mm	Order-No.	Order-No.	mm	mm	Order-No.	Order-No.
500	200	353.342	395.905	500	200	353.242	395.805
500	250	353.305	395.902	500	250	353.205	395.802
500	300	353.343	395.902	500	300	353.243	395.802
500	400	353.344	395.901	500	400	353.244	395.801
500	500	353.345	395.901	500	500	353.245	395.801
600	200	353.322	395.906	600	200	353.222	395.806
600	250	353.306	395.903	600	250	353.206	395.803
600	300	353.323	395.903	600	300	353.223	395.803
600	400	353.324	395.904	600	400	353.224	395.804
600	500	353.326	395.904	600	500	353.225	395.804
800	200	353.352	395.908	800	200	353.252	395.808
800	250	353.308	395.907	800	250	353.208	395.807
800	300	353.353	395.907	800	300	353.253	395.807
800	400	353.354	395.909	800	400	353.254	395.809
800	500	353.355	395.909	800	500	353.255	395.809
1000	200	353.362	395.910	1000	200	353.262	395.810
1000	250	353.311	395.912	1000	250	353.210	395.812
1000	300	353.363	395.912	1000	300	353.263	395.812
1000	400	353.364	395.911	1000	400	353.264	395.811
1000	500	353.365	395.911	1000	500	353.265	395.811
1500	200	353.372	395.915	1500	200	353.272	395.815
1500	250	353.315	395.917	1500	250	353.215	395.817
1500	300	353.373	395.917	1500	300	353.273	395.817
1500	400	353.374	395.916	1500	400	353.274	395.816
1500	500	353.375	395.916	1500	500	353.275	395.816
2000	200	353.382	395.920	2000	200	353.282	395.820
2000	250	353.320	395.922	2000	250	353.220	395.822
2000	300	353.383	395.922	2000	300	353.283	395.822
2000	400	353.384	395.921	2000	400	353.284	395.821
2000	500	353.385	395.921	2000	500	353.285	395.821
2500	200	353.392	395.925				
2500	250	353.325	395.926				
2500	300	353.393	395.926				
2500	400	353.394	395.927				
2500	500	353.395	395.927				
3000	200	353.332	395.930				
3000	250	353.330	395.931				
3000	300	353.333	395.931				
3000	400	353.334	395.932				
3000	500	353.335	395.932				
4000	200	353.346	395.940				
4000	250	353.340	395.941				
4000	300	353.347	395.941				
4000	400	353.348	395.942				
4000	500	353.349	395.942				

Zusatzleistungen *Additional services*(Mehrpreis) *(Additional price)*

Schutzklasse IP66 337.902

*Protection class IP66*

Ersatzbatterie Ø 20 mm 230.228

*Spare battery Ø 20 mm*

Datenausgangskabel OPTO USB 337.901

*Data cable for pc-connection***Neu!****Mehrpreis für Ausführung mit Haken 353.901***Additional price for description with hook*Zusatzleistungen *Additional services*(Mehrpreis) *(Additional price)*

Nonius-Sonderteilung 1/50 mm 336.380

*Special vernier graduation 1/50 mm*

Nonius-Sonderteilung 1/1000" 336.379

*Special vernier graduation 1/1000"***Neu!****Ausführung mit Haken 30 x 100 mm 353.901***Description with hook 30 x 100 mm*Messbereich  
*Range*Brückenbreite  
*Width of bridge*Transportkiste aus  
Sperrholz (ab Mess-  
bereich 1000 mm oder  
Brückenbreite 500 mm  
inklusive)*Transport cases are  
made of plywood  
(from 1000 mm range  
or 500 mm width of  
bridge included)*

# ALINOX®-Bremstrommel-Messschieber 315 | 318

Bremstrommel-Messschieber *Brake-Drum-Callipers*



ALINOX® Bremstrommel-Messschieber Classic 315



ALINOX® Bremstrommel-Messschieber Digital 318

## ALINOX®-BM Classic 315

Nonius 1/20 mm,  
blendfreie Ablesung  
vernier 1/20 mm,  
anti-glam reading

- Maßstab und Schieber aus Alu-Profil
- Messschnäbel aus rostfreiem gehärtetem Stahl
- Zwei Maßteilungen für direkte Ablesung:  
Aussenmaß ab 0 mm  
Innenmaß ab 50 mm
- Zollteilung auf Anfrage
- mit Feststellschraube
- Messspitzen gehärtet, auswechselbar
- Werksnorm

- *slide and beam made of aluminium-profile*
- *jaws made of stainless steel, hardened*
- *two graduations for direct reading:  
outside starting from 0 mm  
inside starting from 50 mm*
- *inch-sizes on request*
- *with fixing-screw*
- *hardened measuring pins, changeable*
- *in-house standard*

## ALINOX®-BM Digital 318

Ablesung 0,01 mm / 0,0005",  
reading 0.01 mm / 0.0005"

- Maßstab und Schieber aus Alu-Profil
- Messschnäbel aus rostfreiem gehärtetem Stahl
- mit Vormaßeinstellung und Hold-Funktion
- Datenausgang RS 232/Opto
- Sylvac-Elektronik
- mit Feststellschraube
- Messspitzen gehärtet, auswechselbar
- Werksnorm

- *beam and cursor made of aluminium-profile*
- *jaws made of stain-less steel, hardened*
- *pre-set-button and hold function*
- *data-output RS 232/Opto*
- *Sylvac-Electronic*
- *with fixing screw*
- *hardened measuring pins, changeable*
- *in-house standard*





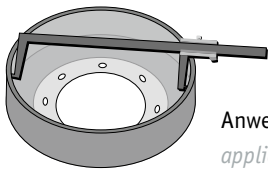

Anwendung  
application



Messbereich  
Range



Schnabellänge  
Jaw length



Transportkiste aus Sperrholz (ab Messbereich 1000 mm inklusive)  
Transport cases are made of plywood (from 1000 mm range included)



mm



mm

Brems-  
trommelm.



Order-No.

analog mit gedruckter Teilung  
analog with printed graduation

500	150	315.305	396.901
500	250	315.307	396.902

analog mit Laserteilung  
analog with laser-graduation

500	150	316.305	396.901
500	250	316.307	396.902
600	150	316.308	396.904
600	250	316.309	396.905
800	150	316.310	396.907
800	250	316.311	396.908
1000	150	316.312	396.910
1000	250	316.313	396.911



mm



mm

Brems-  
trommelm.



Order-No.

digital  
digital

500	150	318.205	396.901
500	250	318.207	396.902
600	150	318.208	396.904
600	250	318.209	396.905
800	150	318.210	396.907
800	250	318.211	396.908
1000	150	318.212	396.910
1000	250	318.213	396.911

Zubehör accessories

Ersatzspitzenpaar 5 x 10 mm Pair of spare pins 5 x 10 mm	312.110
---	---------

## ALINOX®-Stangenzirkel 608

Stangenzirkel Marking Calliper



ALINOX®-Stangenzirkel 608

### ALINOX® 608

Stangenzirkel  
Marking Calliper

- Maßstab und Schieber aus Alu-Profil
- Messspitzen aus rostfreiem gehärtetem Stahl
- Nonius 1/20 mm
- blendfreie Ablesung
- Zollteilung auf Anfrage

- mit Feststellschraube
- Werksnorm
- slide and beam made of aluminium-profile
- points stainless steel, hardened
- vernier 1/20 mm
- anti-glam reading
- inch-sizes on request
- with fixing-screw
- in-house standard



Messbereich  
Range



Stützenlänge  
Length of points



Transportkiste aus Sperrholz (ab Messbereich 1000 mm inklusive)  
Transport cases are made of plywood (from 1000 mm range included)



mm



mm

Stangen-  
zirkel

Order-No.



Order-No.

20-300	70	608.303	
20-400	70	608.304	
20-500	70	608.305	
20-600	70	608.306	
20-800	70	608.308	
20-1000	70	608.310	395.910
20-1200	70	608.312	395.915
20-1500	70	608.608	395.915
20-2000	70	608.320	395.920
20-2500	70	608.325	395.925
20-3000	70	608.330	395.930
20-4000	70	608.340	395.940

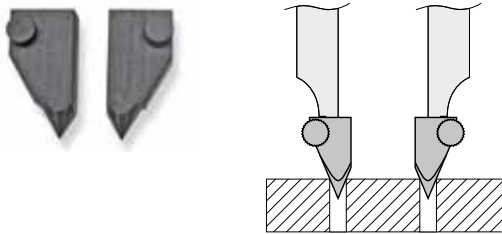

Anwendung *application*

### Mess- und Anreißspitzen 328

*Marking- and measuring-points*

- für Lochdurchmesser von 1 bis 12 mm (Messbereich beginnt dann ab 10 mm)
- rostgeschützt
- zum Aufsetzen auf Messschnäbel
- *for hole-distance measurement 1 to 12 mm*
- *rustproofed*
- *to be fixed at the jaw's end*

Abmessung *Dimension*      Order-No.

Anreiß- und Messspitzen <i>Marking- and measuring-points</i> für Lochmaßansatz	
10 mm	328.202

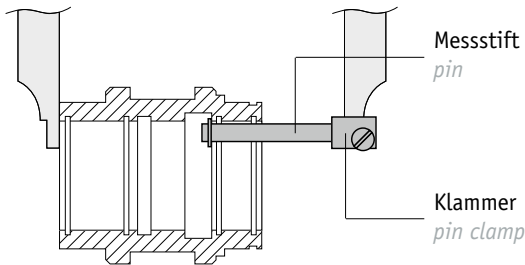

### Zubehör für Innenmessung 328

*Accessories for internal measurements*

- rostgeschützt
- zum Ankleben an die Messschnäbel
- *rustproofed*
- *to be fixed at the jaw's end*

Abmessung *Dimension*      Order-No.

Klammer <i>pin clamp</i> für Lochmaßansatz	
10 mm	328.213
Messstift <i>pin</i>	
15.5 mm	328.204
50.0 mm	328.206
100.0 mm	328.207



### Messstiftverlängerungen 346

*Set of extension rods*

- koppelbar
- alle Ausführungen paarweise
- *adaptable*
- *all descriptions in pairs*

Abmessung *Dimension*      Order-No.

30 mm	346.522
40 mm	346.523
50 mm	346.524
60 mm	346.525
70 mm	346.526
80 mm	346.527
90 mm	346.528
100 mm	346.529

Set, bestehend aus

<i>Set, containing</i>	
30, 40, 50,	
60, 70 mm	346.520

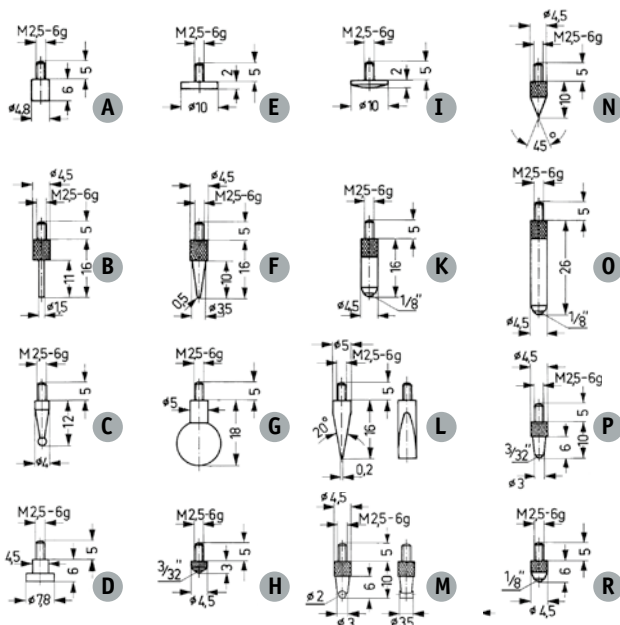

### Messeinsätze 346

*Accessories*

- alle Ausführungen **paarweise**
- Standard: Ausführung R
- G: bitte gewünschten Durchmesser angeben; von 7 – 11 mm erhältlich
- *all designs in pairs*
- *standard: design R*
- *G: please indicate the diameter you need, from 7 – 11 available*

Ausführung *Discription*      Order-No.

A	346.601
B	346.605
C	346.609
D	346.613
E	346.602
F	346.606
G	346.610
H	346.614
I	346.603
K	346.607
L	346.611
M	346.615
N	346.604
P	346.612
R	346.616

## Transportkiste aus Sperrholz 395

*Transport-Case made of plywood 395*

- Standardmäßig werden alle in diesem Prospekt aufgeführten ALINOX® Messschieber ab einem Messbereich von 1000 mm oder einer Schnabellänge ab 500 mm in einer einfachen Transportkiste aus Sperrholz geliefert. Diese ist bereits im Preis enthalten.
- *All ALINOX® products, which you can find in this brochure will be delivered - starting from 1000 mm range or 500 mm jaw length - in a simple transport-case, made of plywood. Already included in the price..*

## Holz-Etui 396

*High-quality Wooden-Case 396*

- Gerne können Sie für die Aufbewahrung unserer Messschieber auch formschöne, nach deutscher Tischlerkunst hergestellte Etuis aus Rotbuche beziehen.
  - gezinkt verleimt, geschliffen, lackiert
  - *High-quality wooden cases, made of redbeech in best joiner's art-work*
- 
- Als Werbung auf Transportkisten und Etuis ist Sieb- oder Tampondruck, Prägung oder Brennstempel auf Anfrage möglich.



Transportkiste Type 395



Holz-Etui Type 396

## ALINOX®-Prüfzertifikate

Prüfzertifikate nach Werksnorm auf Anfrage *Certificates and in-house standards*

### Prüfzertifikate für ALINOX®-Werkstattmessschieber

*Certificates for ALINOX®-Workshop-Callipers*

### Werksnorm für ALINOX®-Werkstattmessschieber

*In-house standard for ALINOX®-Workshop-Callipers*

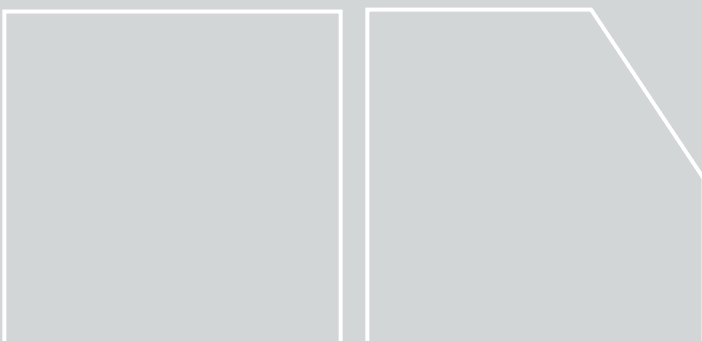

Ihr Fachhändler *Your specialized dealer*

Technische und optische Änderungen behalten wir uns ohne ausdrückliche Ankündigung vor. Unsere allgemeinen Geschäftsbedingungen entnehmen Sie bitte der aktuellen Preisliste. *Technical and optical deviations prior to subject without any anticipated information. Business terms according the current price list.*

*Scala*<sup>®</sup>

messzeuge

scala messzeuge gmbh  
kelterstraße 55  
d-73265 dettingen/teck  
tel: +49(0)7021-72592- 0  
fax: +49(0)7021-72592-24  
e-mail: [info@scala-mess.de](mailto:info@scala-mess.de)  
i-net: [www.scala-mess.de](http://www.scala-mess.de)