











2021

 **Beta**

SHOP

in Shop



-  **Soluzioni espositive** per il punto vendita
-  **Display solutions** for sales points
-  **Solutions d'exposition** pour le point de vente
-  **Soluciones expositivas** para el punto de venta
-  **Ausstellungslösungen** für den Verkaufspunkt
-  **Display's VOOR** de verkooppunten
-  **Rozwiązania wystawiennicze** dla punktów sprzedaży
-  **Állványok** értékesítési helyekre
-  **Soluções de expositores** para pontos de venda
-  **Λύσεις προβολής** για σημεία πώλησης

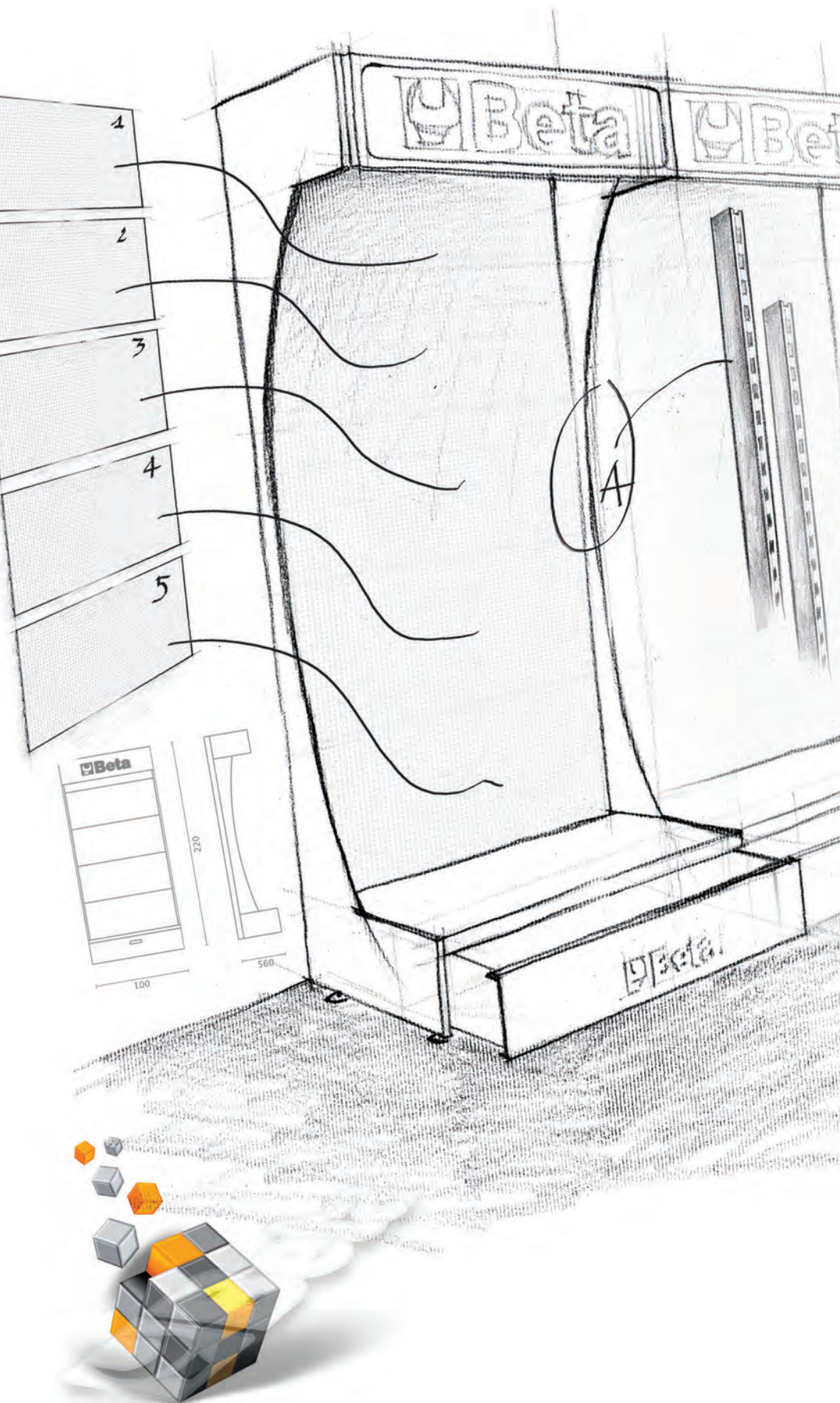

 Le immagini riprodotte sono indicative.

Beta Utensili S.p.A. si riserva il diritto di apportare aggiornamenti e migliorie alla propria gamma produttiva senza preavviso.

 The pictures are given by way of example.

Beta Utensili reserve the right to update and enhance their product range without notice.

 Les renseignements et photos figurant dans ce chapitre sont donnés à titre indicatifs et n'ont aucune valeur contractuelle.

Beta Utensili se réserve le droit de mettre à jour ou d'accroître sa gamme de produits sans préavis, et sans obligation d'effectuer les modifications sur les modèles vendus antérieurement.

 Las fotos que se reproducen sirven tan sólo de indicación.

Beta Utensili se reserva el derecho de aportar actualizaciones y mejoras a su gama de productos sin previo aviso.

 Die dargestellten Bilder dienen zur Orientierung.

Die Firma Beta Utensili behält sich das Recht vor, ihre Produktpalette ohne Vorankündigung anzupassen oder zu verbessern.

 De afbeeldingen dienen uitsluitend als voorbeeld.

Beta utensili behoudt zich het recht voor de producten te wijzigen en te verbeteren zonder voorafgaand bericht.

 Zamieszczone zdjęcia narzędzi należy traktować jako przykładowe.

Beta zastrzega sobie prawo do wprowadzania zmian oraz udoskonaleni w swoich produktach bez powiadomienia.

 A nyomtatott képek tájékoztató jellegűek. Beta Utensili cég fenntartja magának azt a jogot, hogy áruválasztékán előzetes bejelentés nélkül változtatást hajtsen végre.

 Todas as informações e imagens que aparecem neste catálogo são meramente indicativas e sem qualquer valor contratual.

A Beta Utensili reserva-se ao direito de alterar ou actualizar a sua gama de produtos sem aviso prévio, e sem obrigação de efectuar qualquer modificação sobre os modelos vendidos anteriormente.











 Οι απεικονίσεις παρατίθενται σαν παράδειγμα.

Η Beta Utensili διατηρεί το δικαίωμα να τροποποιεί και να βελτιώνει την σειρά προϊόντων της χώρας χωρίς άλλη ειδοποίηση.











4

-  Introduzione
-  Introduction
-  Introduction
-  Introducción
-  Einleitung
-  Introductie
-  Wstęp
-  Bevezetés
-  Introdução
-  Εισαγωγή

19

-  Proposte espositive: moduli singoli
-  Display suggestions: individual modules
-  Propositions d'exposition : modules simples
-  Propuestas expositivas: módulos individuales
-  Ausstellungsangebote: Einzelmodule
-  Display suggesties: individuele modules
-  Propozycje ekspozycji - pojedyncze moduły
-  Állvány ajánlatok: egyedi modulok
-  Sugestão de expositores: módulos individuais
-  Προτάσεις προβολής: αυτόνομες μονάδες











105

-  Proposte espositive: espositori completi
-  Display suggestions: complete displays
-  Propositions d'exposition : présentoirs complets
-  Propuestas expositivas: expositores completos
-  Ausstellungsangebote: Komplette Ständer
-  Display suggesties: complete displays
-  Propozycje ekspozycji - kompletne zestawy
-  Állvány ajánlatok: komplett állványok
-  Sugestão de expositores: expositores completos
-  Προτάσεις προβολής: πλήρη εκθετήρια

112

-  Accessori
-  Accessories
-  Accessoires
-  Accesorios
-  Zubehör
-  Accessoires
-  Akcesoria
-  Tartozékok
-  Acessórios
-  Εξαρτήματα

125

-  Strumenti di comunicazione
-  Communication
-  Outils de communication
-  Instrumentos de comunicación
-  Kommunikationsinstrumente
-  Communicatie mediums
-  Środki i pomoce reklamowe
-  Kommunikációs eszközök
-  Meios de comunicação
-  Μέσα προβολής



Introduzione

L'esposizione del prodotto nei punti vendita è l'aspetto strategico per la conoscenza e l'acquisto degli articoli da parte dell'utente finale. Beta Utensili ha da sempre dedicato molte risorse nella ricerca e sviluppo di nuovi supporti e strumenti di comunicazione in grado, non solo di aumentare la visibilità del prodotto e stimolare l'interesse della clientela, ma anche di razionalizzarne e ottimizzarne l'esposizione.

Oggi Beta Utensili introduce un moderno sistema espositivo in linea con le nuove strategie di vendita, in grado di soddisfare le molteplici e differenti necessità dei propri clienti.

I concetti cardine del nuovo sistema espositivo sono:

- **Modularità:** massima flessibilità nella composizione degli assortimenti e dell'area espositiva.
- **Redditività:** assortimenti ad alta rotazione e adeguati alle reali esigenze del mercato.
- **Efficienza espositiva:** organizzazione e ottimizzazione dello spazio di vendita secondo criteri merceologici e di utilizzo.

A completamento del nuovo sistema espositivo, Beta Utensili ha sviluppato una serie completa di strumenti di comunicazione visiva (insegne luminose, banner, pannelli grafici) in grado di personalizzare, identificare ed enfatizzare al meglio i prodotti e l'area Beta.

Introduction

Product displays in sales points play a strategic role: end users directly appreciate and purchase goods on show. Beta Utensili has always invested massively in rationalising and optimising displays, in the research and development of new communication approaches and sales support designed to gain product visibility and encourage/stimulate customer interest.

Beta Utensili today launches a modern display system that satisfies new sales strategies as well as all our customers' various requirements.

The new display system relies on the following quality features:

- **Modularity:** unparalleled flexibility in assembling assortments and in the display area;
- **Cost-effectiveness:** fast-moving products to suit actual market needs;
- **Display efficiency:** sales space organisation and optimisation to meet product visibility and individual needs.

In addition, Beta Utensili supplements the new display system with a wide range of visual communication (luminous signs, banners, graphic panels) designed to effectively customise, identify and emphasise Beta products and area.





Introduction

L'exposition du produit dans les point de vente est l'aspect stratégique pour la découverte et l'achat des articles par l'utilisateur final. Beta Utensili a depuis toujours consacré d'importantes ressources pour la recherche et le développement de nouveaux supports et outils de communication capables non seulement d'augmenter la visibilité du produit et de stimuler l'intérêt de la clientèle, mais également d'en rationaliser et d'en optimiser l'exposition.

Aujourd'hui Beta Utensili présente un système d'exposition moderne parfaitement aligné aux nouvelles stratégies de vente qui est à même de répondre aux exigences nombreuses et variées de sa clientèle. Les concepts clé du nouveau système d'exposition sont les suivants :

- **Modularité** : flexibilité maximale dans la constitution des compositions et de l'espace d'exposition
- **Rentabilité** : compositions constamment renouvelées et adaptées aux exigences réelles du marché
- **Efficacité d'exposition** : organisation et optimisation de l'espace de vente en fonction des critères commerciaux et d'utilisation.

Pour compléter son nouveau système d'exposition, Beta Utensili a mis au point une série complète d'outils de communication visuelle (enseignes lumineuses, bannières, panneaux graphiques) pour personnaliser, identifier et mettre en valeur au mieux les produits et l'espace Beta.

Introducción

La exposición del producto en el punto de venta es el aspecto clave para el conocimiento y la compra de los artículos por parte del usuario final. Beta Utensili siempre ha dedicado recursos importantes a la investigación y desarrollo de nuevos soportes e instrumentos de comunicación capaces no sólo de aumentar la visibilidad del producto y estimular el interés de la clientela, sino también de racionalizar y optimizar su exposición.

Hoy Beta Utensili introduce un moderno sistema expositivo consecuente con sus nuevas estrategias de ventas, capaz de atender el sinfín de necesidades diferentes de sus clientes.

Los conceptos básicos del nuevo sistema expositivo son:

- **Modularidad**: máxima flexibilidad en la composición de los surtidos y del área expositiva.
- **Rentabilidad**: surtidos de alta rotación y adecuados para atender las necesidades reales del mercado.
- **Eficiencia expositiva**: organización y optimización del espacio de ventas conforme a criterios de mercancía y utilización.

Para completar su nuevo sistema expositivo, Beta Utensili ha desarrollado una serie completa de instrumentos de comunicación visual (rótulos, letreros luminosos, banners, paneles gráficos) capaces de personalizar, identificar y resaltar perfectamente los productos y el área Beta.



Einleitung

Die Ausstellung des Produkts in den Verkaufspunkten repräsentiert einen strategischen Aspekt hinsichtlich Bekanntmachung und Kauf der einzelnen Artikel durch den Endkunden. Beta Utensili hat immer viele Ressourcen für die Erforschung und Entwicklung neuer Kommunikationsträger und -systeme, die nicht nur die Produktsichtbarkeit verbessern, sondern auch die Ausstellung an sich rationalisieren und optimieren, aufgebracht. Nun führt Beta Utensili ein modernes und auf die neuen Verkaufsstrategien abgestimmtes Ausstellungssystem ein, das den zahlreichen und unterschiedlichen Kundenansprüchen bestens entspricht. Die Angelpunkte des neuen Ausstellungssystems sind:

- **Modularität:** maximale Flexibilität bei der Zusammensetzung der Sortimente und des Ausstellungsbereichs.
- **Rentabilität:** hoher Umschlag des Sortiments in Übereinstimmung mit den realen Marktanforderungen.
- **Ausstellungseffizienz:** Organisation und Optimierung des Verkaufsraums nach Waren- und Nutzungskriterien.

Zur Vervollständigung des Ausstellungssystems hat Beta Utensili eine vollständige Serie an visuellen Kommunikationsinstrumenten (Leuchtschilder, Banner, Grafik-Paneele) entwickelt, mit deren Hilfe die Produkte und der Bereich Beta personalisiert, identifiziert und hervorgehoben werden.

Introductie

Product displays spelen een grote strategische rol bij de verkooppunten. Ze zorgen ervoor dat de klant bekend wordt met de identiteit van Beta en geven een impuls tot aanschaf van Beta producten. Wij van Beta, blijven daarom zwaar investeren op het gebied van innovatieve communicatiemediums om de klant zoveel mogelijk te informeren over de kwaliteit en diversiteit van onze producten en optimalisatie van de displays.

We zijn daarom ook trots dat we u een nieuw display systeem kunnen presenteren dat nieuwe verkoop strategieën toepast en voldoet aan de meest uiteenlopende eisen van het verkooppunt. Het nieuwe display systeem heeft de volgende kenmerken als basis:

- **Modulair:** ongekende flexibiliteit in de zowel de assortimenten als de displays zelf;
- **Kosten effectiviteit:** snel lopende producten die voldoen aan de vraag uit de markt;
- **Display effectiviteit:** organisatie en optimalisatie van de verkoopruimte naar product en gebruikswijze.

Als toevoeging, hebben wij van Beta het nieuwe display systeem aangevuld met een uitgebreid assortiment van visuele communicatie mediums (wand lampen, banners en grafische panelen) om de klanten zo goed mogelijk te informeren over de identiteit en kwaliteit van Beta.





Wstęp

Sposób eksponowania produktów w punktach sprzedaży odgrywa bardzo ważną rolę podczas zapoznawania użytkowników z ofertą i zachęcania ich do nabycia towarów. Beta Utensili zawsze dążyła do ulepszania i racjonalizacji regałów wystawienniczych oraz angażowała się w badania i rozwój nowych środków i pomocy reklamowych w celu uzyskania jak największej widoczności produktów służącej zwiększaniu zainteresowania klientów.

Beta Utensili wprowadza obecnie nowoczesny system wystawienniczy dopasowany do najnowszych strategii sprzedaży i zdolny spełnić różnorodne wymagania klientów.

Nowy system wystawiennictwa oparty jest na następujących oryginalnych cechach:

- **Modułowość:** niezrównana elastyczność zarówno w zakresie wyboru towarów jak i układu ekspozycji;
- **Oszczędność:** towary szybko rotujące odpowiadające bieżącym potrzebom rynku;
- **Wydajność:** organizowanie i optymalizacja powierzchni handlowej według kryteriów użytkowych z uwzględnieniem specyfiki poszczególnych towarów.

Dodatkowo Beta Utensili zaopatrzyła nowy system wystawienniczy w pełny zakres wizualnych środków reklamowych (podświetlane szyldy, banery, panele graficzne) o dużej przystosowalności montażowej przeznaczonych do identyfikacji i zwracania uwagi na produkty Bety i ich powierzchnie wystawiennicze.

Bevezetés

A termékek bemutatása az értékesítési helyeken azt a stratégiát képviseli, melynek célja a termékek közvetlen ismertetése és értékesítése a végfelhasználók számára. Beta Utensili folyamatosan újításokat kezdeményez a kommunikációs hordozók és rendszer, valamint annak fejlesztése érdekében, mivel ezzel nemcsak a termékek megismertetését segíti elő, hanem a bemutatást is racionalizálja és optimalizálja. Beta Utensili modern és új eladási stratégiát dolgozott ki a bemutató rendszert illetően, mely a különböző vevők eltérő igényeinek maximálisan megfelel.

A bemutató rendszerek fő jellemzői:

- **Alkalmazkodási képesség:** maximális rugalmasság a bemutatott választék/terület arányának kialakításánál.
- **Gazdaságosság:** a választék gyors változtatása a tényleges piaci igényeknek megfelelően.
- **A bemutatás hatékonysága:** Az eladótér berendezéseinek optimalizálása az áru/felhasználási terület szerint.

A bemutató rendszer kiegészítésére a Beta Utensili a vizuális kommunikációs eszközök teljes skáláját (fényreklám, zászlók, grafikák, panelek) fejlesztette ki, melyek segítségével a termékek azonnal a Beta márkánévvel azonosulnak.





Introdução

A disposição de produtos nos postos de venda é uma estratégia fundamental para os utilizadores finais se familiarizarem com os produtos e assim os adquirirem. Nós, Beta Utensili, investimos maciçamente na pesquisa e desenvolvimento de novos meios de promoção e de novos projectos que aumentem a visibilidade dos produtos de forma a encorajar o interesse dos clientes, racionalizando e optimizando os expositores. Nós, Beta Utensili, procedemos com agrado ao lançamento de um novo e moderno sistema de expositores para uma nova estratégia de vendas, capaz de satisfazer as mais diversas exigências dos nossos clientes.

O novo sistema de expositores tem as seguintes imagens de marca:

- **Modularidade:** flexibilidade inigualável em jogos de ferramentas e área de exposição;
- **Rentabilidade:** produtos de elevada rotatividade para responderem às necessidades do mercado;
- **Exposição eficiente:** organizando e optimizando espaços de venda de acordo com os produtos e critérios de utilização.

Adicionalmente, nós, Beta Utensili, completamos os novos sistemas de expositores com uma polivalente gama de meios visuais (sinais luminosos, banners, painéis gráficos) projectados para efectivamente personalizar, identificar e realçar a área e os produtos Beta.

ΕΙΣΑΓΩΓΗ

Τα εκθετήρια προϊόντων στα σημεία πώλησης παίζουν στρατηγικό ρόλο αν θέλουμε οι τελικοί χρήστες να γνωρίσουν και να αγοράζουν κάποιο προϊόν. Στην Beta Utensili ανέκαθεν επενδύαμε έντονα στην έρευνα και ανάπτυξη νέων μέσων προβολής και βοηθημάτων, με στόχο να κάνουμε γνωστά τα προϊόντα και να προσελκύσουμε το ενδιαφέρον της πελατειακής βάσης, προσπαθώντας ταυτόχρονα να εκλογικεύουμε και να βελτιστοποιούμε τα εκθετήρια. Εμείς στην Beta Utensili είμαστε τώρα στην ευχάριστη θέση να παρουσιάσουμε ένα νέο, μοντέρνο σύστημα εκθετηρίων προσαρμοσμένο σε σύγχρονες στρατηγικές πώλησης και ικανό να καλύψει τις διαφοροποιημένες απαιτήσεις των πελατών μας.

Το νέο σύστημα εκθετηρίων προσφέρει τα παρακάτω πλεονεκτήματα:

- **Ευελιξία:** απaráμιλλη ευελιξία σε συλλογές αλλά και σε επιφάνεια παρουσίασης
- **Οικονομική αποδοτικότητα:** προϊόντα με μεγάλη κινητικότητα που συμβαδίζουν με τις ανάγκες τις αγορές
- **Προβολή:** οργάνωση και βέλτιστη εκμετάλλευση του χώρου των πωλήσεων με κριτήρια βασισμένα στο ποιόν και τη χρήση του

Επιπλέον, εμείς στην Beta Utensili συμπληρώσαμε το νέο σύστημα εκθετηρίων με μια περιεκτική σειρά μέσων οπτικής προβολής (φωτεινές επιγραφές, πανό, πινακίδες με γραφικά) σχεδιασμένα να ξεχωρίζουν και να τονίζουν τα προϊόντα Beta μέσα στο χώρο του κάθε πελάτη.



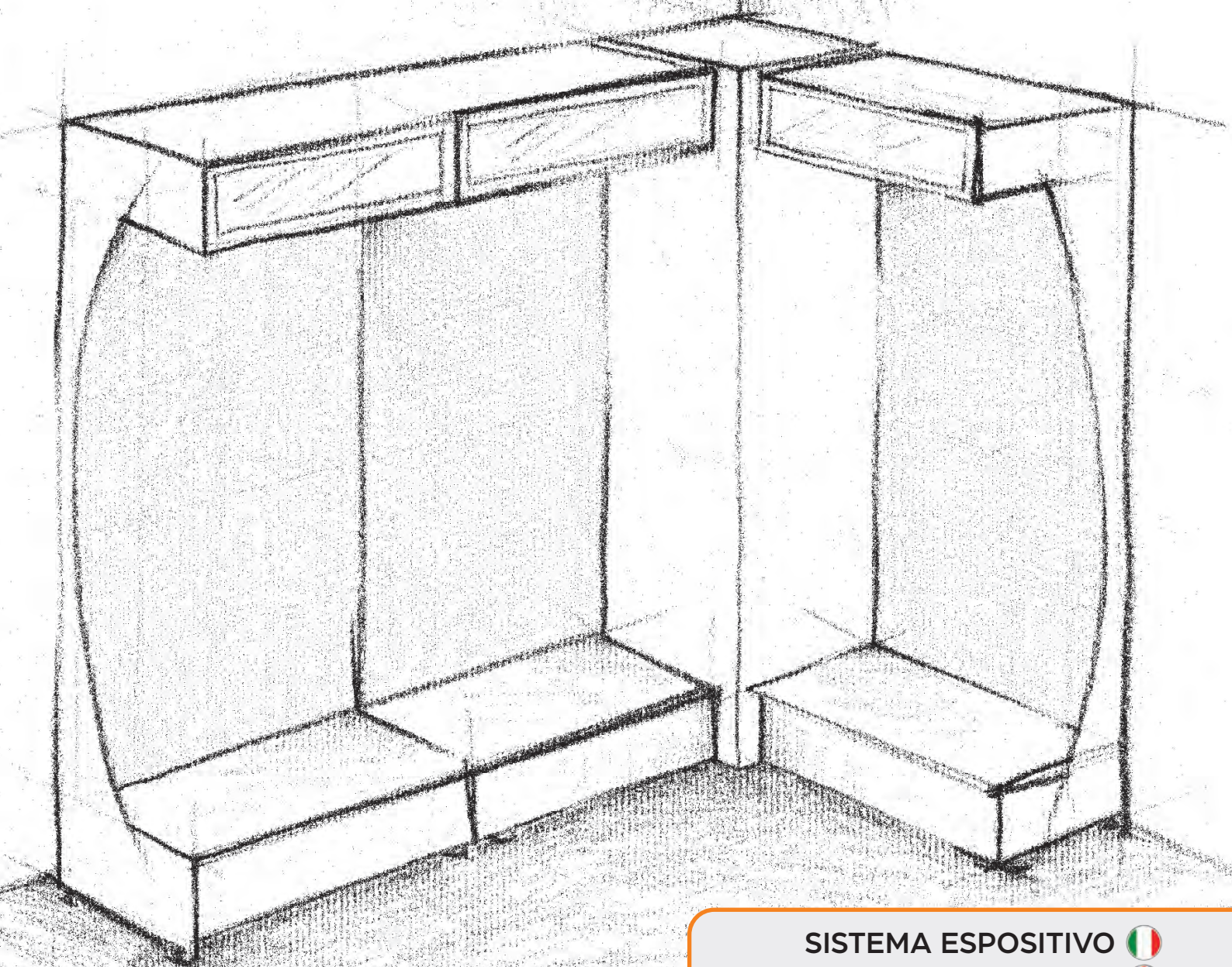

- SISTEMA ESPOSITIVO 
- DISPLAY SYSTEM 
- SYSTÈME D'EXPOSITION 
- SISTEMA EXPOSITIVO 
- AUSSTELLUNGSSYSTEM 
- DISPLAY SYSTEEM 
- SYSTEM WYSTAWIENNICZY 
- BEMUTATÓ RENDSZER 
- SISTEMA DE EXPOSITORES 
- ΣΥΣΤΗΜΑ ΕΚΘΕΤΗΡΙΩΝ 





SISTEMA ESPOSITIVO

La nuova struttura è costituita da diversi elementi (montanti, pannelli, basamento) studiati e realizzati secondo gli standard attualmente applicati nei negozi di utensileria/ferramenta. Ne risulta un sistema pratico e funzionale in grado di adattarsi a qualsiasi esigenza espositiva. La struttura è autoportante e non richiede fissaggio a parete. Ogni componente evidenzia colori ed elementi caratteristici in grado di enfatizzare l'immagine Beta. Nove diversi ganci, progettati appositamente, permettono di esporre in maniera pratica e razionale tutti i prodotti Beta.



DISPLAY SYSTEM

The new system is composed of several different parts (uprights, panels, base) designed and built according to the standards currently applied to tool/hardware shops. The result is a both practical and functional system that can adapt to any display requirement. The frame is self-supporting therefore does not have to be fixed to the wall. Each part displays typical colours and features designed to emphasise Beta image. Nine different specially designed hooks ensure a practical, rational display of all of Beta products.



SYSTÈME D'EXPOSITION

Cette nouvelle structure est constituée de plusieurs éléments (montants, panneaux, base) conçus et réalisés selon les standards actuellement adoptés dans les magasins d'outillage/quincaillerie. Ce système pratique et fonctionnel répond parfaitement à toutes les exigences d'exposition. Cette structure est autoportante et ne nécessite aucune fixation au mur. Chaque composant souligne des couleurs et des éléments caractéristiques qui permettent de renforcer l'image Beta. Neuf différents crochets de conception spéciale permettent d'exposer de façon pratique et rationnelle tous les produits Beta.

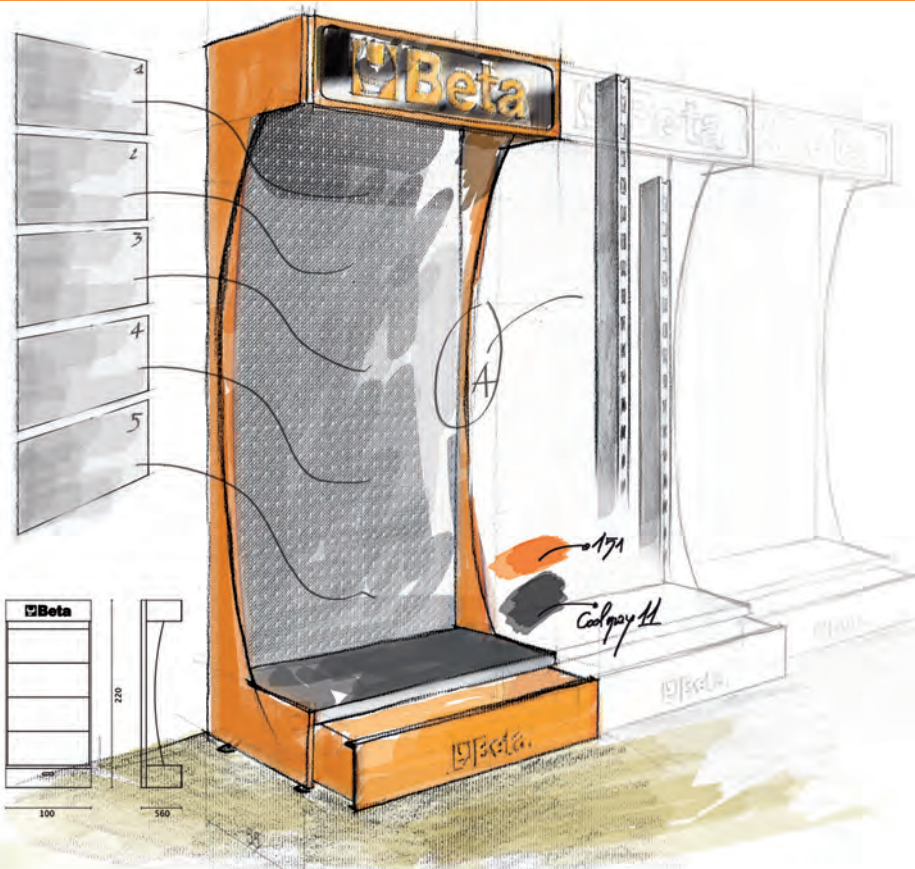

SISTEMA EXPOSITIVO

La nueva estructura se compone de diferentes elementos (montantes, paneles, base) estudiados y realizados conforme a los estándares actualmente aplicados en las tiendas de herramientas/ferretería. De ello se desprende un sistema práctico y funcional capaz de adaptarse a cualquier necesidad expositiva. La estructura es autoportante y no precisa de fijación en la pared. Cada componente destaca colores y elementos característicos capaces de resaltar la imagen Beta. Nueve ganchos diferentes, diseñados especialmente, permiten exponer de manera práctica y racional todos los productos Beta.



AUSSTELLUNGSSYSTEM

Die neue Struktur setzt sich aus verschiedenen Elementen (Ständer, Panele, Grundgestell) zusammen, die auf der Grundlage der derzeit von Eisenwaren- und Werkzeuggeschäften angewendeten Standards entwickelt und hergestellt wurden. Die selbsttragende Struktur bedarf keiner Wandbefestigung. Jede Komponente hebt zur Unterstreichung des Images Beta charakteristische Farben und Elemente hervor. Neun unterschiedliche und eigens entwickelte Haken garantieren eine praktische und rationale Ausstellung aller Produkte Beta.



DISPLAY SYSTEEM

Het display systeem bestaat uit verschillende onderdelen (Basis frame, panelen en zijwanden). Het is gebaseerd op de standaard die momenteel wordt gebruikt in de gereedschap/iijzerwaren zaken. Het display systeem is dus zowel praktisch als functioneel en voldoet aan alle eisen. Het display systeem is zelfdragend en hoeft dus niet vast gezet te worden aan een muur. Elk onderdeel bevat de typische kleuren van Beta's identiteit. Negen verschillende unieke haken zorgen voor een praktische en functionele indeling van alle Beta producten.





SYSTEM WYSTAWIENNICZY

Nowy system wystawienniczy składa się z wielu części (wsporniki pionowe, panele, podstawy) zaprojektowanych i wytworzonych wg aktualnych standardów stosowanych w sklepach narzędziowych, dzięki czemu jest praktyczny i wyróżnia się pod względem funkcjonalnym, zaspakajając wszelkie wymagania w zakresie wystawiennictwa. Samonośna rama nie wymaga zamocowania do ściany. Każda część posiada charakterystyczne kolory i oznaczenia podkreślające wizerunek firmy Beta. Dziewięć różnych, specjalnie zaprojektowanych haków pozwala na sprawne i racjonalne prezentowanie towarów Bety.



BEMUTATÓ RENDSZER

Az új struktúra felöleli a különböző elemeket (állványok, panelek, alapállvány), melyeket jelenleg a vasáru- és szerszámüzletekben található standard alapján fejlesztettek ki és gyártottak le. Az önhordó szerkezetnél a falhoz való rögzítés nem szükséges. Minden egyes alkotó elem a Beta image-t hangsúlyozza a jellegzetes színekkel és elemekkel. Új, különböző és külön erre a célra fejlesztett szerelvények garantálják a Beta valamennyi termékének praktikus és racionális bemutatását.



SISTEMA DE EXPOSITORES

O novo sistema é composto por várias partes diferentes (colunas, painéis, base) projectado e construído de acordo com os padrões actuais requeridos pelas lojas de ferramentas. Assim salienta-se as suas formas práticas e funcionais que respondem a qualquer exigência de exposição. A estrutura de apoio não tem que ser fixada à parede. Cada parte do expositor tem cores e formas que realçam a imagem Beta. Nove tipos de ganchos diferentes especialmente projectados, asseguram uma exposição de todos os produtos Beta de forma prática e racional.

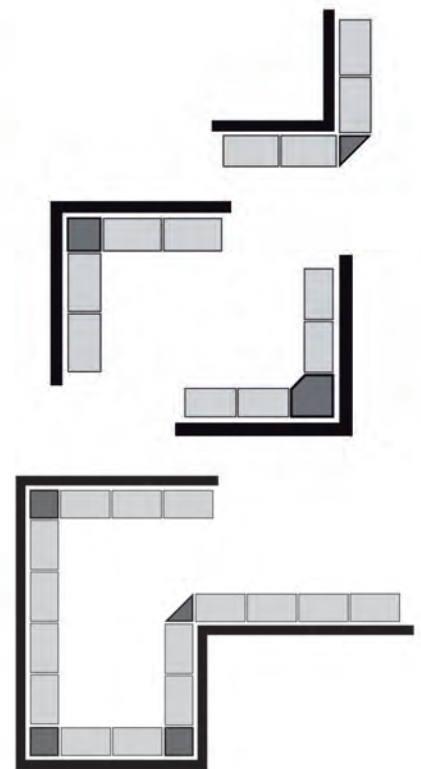
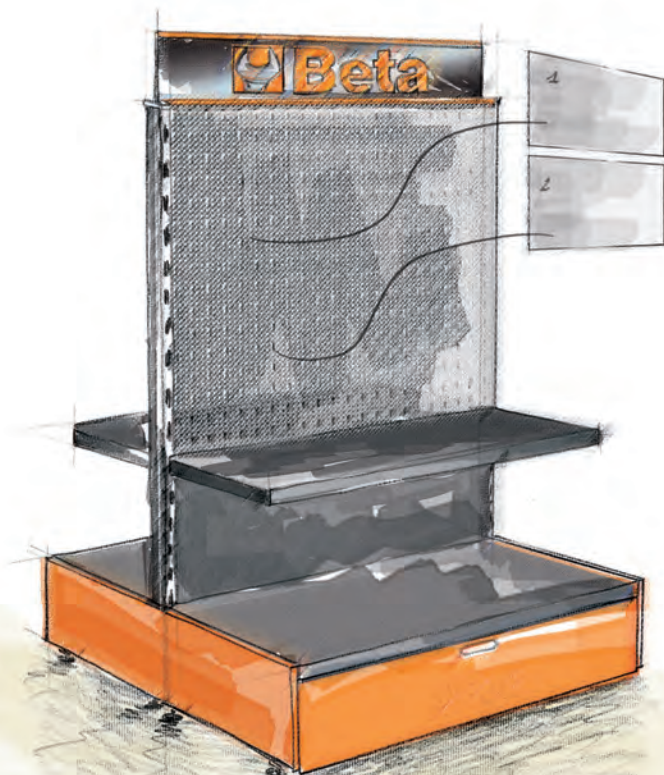

ΣΥΣΤΗΜΑ ΕΚΘΕΤΗΡΙΩΝ

Το νέο σύστημα απαρτίζεται από αρκετά διαφορετικά κομμάτια (όρθια, πίνακες, βάση) σχεδιασμένα και κατασκευασμένα σύμφωνα με τα πρότυπα που επικρατούν σήμερα στα καταστήματα εργαλείων/σιδηρικών. Έτσι, είναι πρακτικά και συγχρόνως λειτουργικά, ικανοποιώντας οποιαδήποτε ανάγκη παρουσίασης. Ο αυτοφερόμενος σκελετός δεν χρειάζεται να στερεωθεί σε τείχος. Κάθε κομμάτι παρουσιάζει χαρακτηριστικά χρώματα και αντικείμενα με στόχο την προβολή της εικόνας Beta. Εννέα διαφορετικά, ειδικά σχεδιασμένα στηρίγματα/γάντζοι βοηθάνε σε πρακτική και εκλογικευμένη παρουσίαση όλων των προϊόντων Beta.



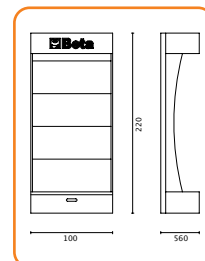
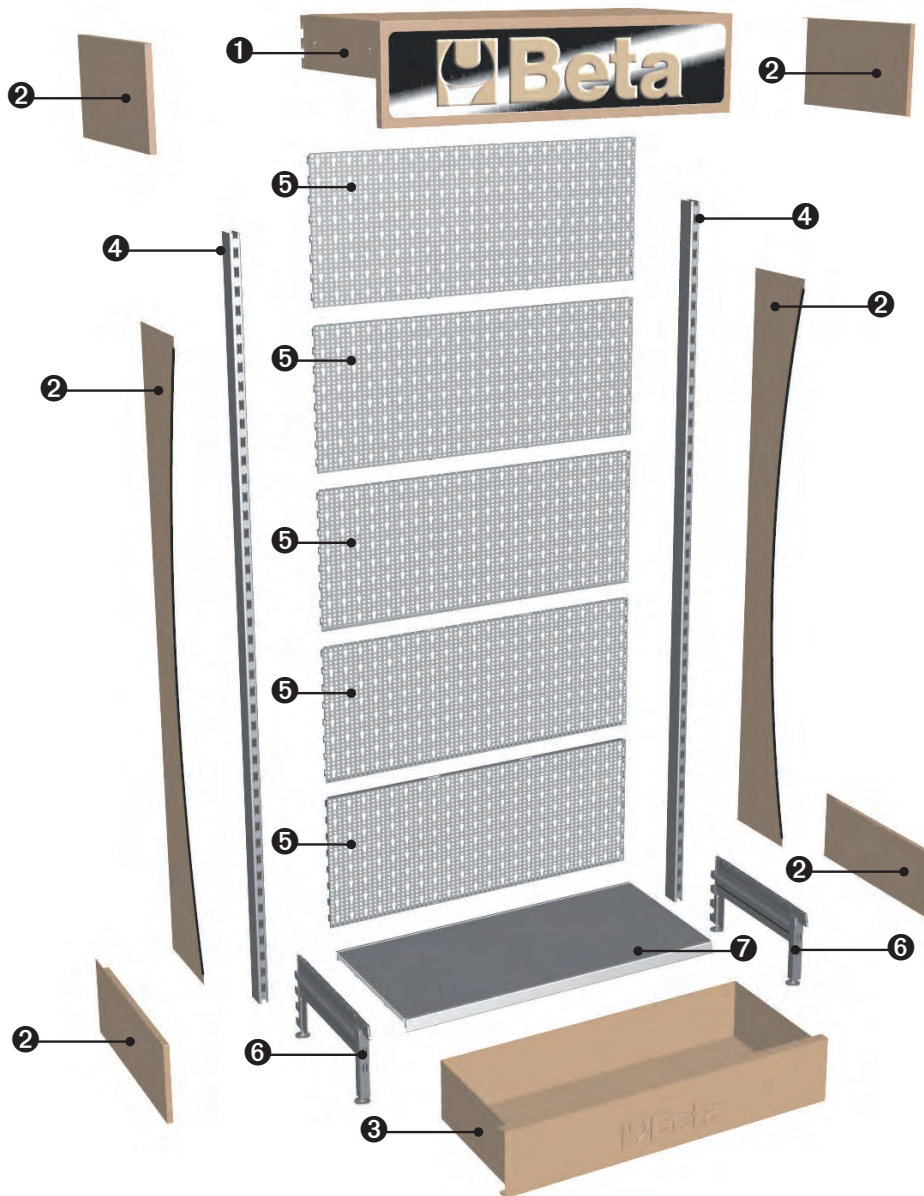

Espositore a parete

- 1 Insegna luminosa
- 2 Spalle
- 3 Cassetto base
- 4 Montante
- 5 Modulo espositivo
- 6 Piede base
- 7 Ripiano base



Wall display

- 1 Luminous sign
- 2 Side panels
- 3 Base drawer
- 4 Upright
- 5 Display module
- 6 Support
- 7 Base shelf



Présentoir mural

- 1 Enseigne lumineuse
- 2 Flancs
- 3 Tiroir de base
- 4 Montant
- 5 Module d'exposition
- 6 Piètement
- 7 Étagère de base



Expositor de pared

- 1 Letrero luminoso
- 2 Laterales
- 3 Cajón base
- 4 Montante
- 5 Módulo expositivo
- 6 Pie base
- 7 Estante base



Wandständer

- 1 Leuchtschild
- 2 Seitenteile
- 3 Basiskasten
- 4 Ständer
- 5 Ausstellungsmodul
- 6 Basisfuß
- 7 Basisbord



Muur display

- 1 Lichtbak
- 2 Zij panelen
- 3 Vloer lade
- 4 Verticale paneelhouder
- 5 Wand paneel
- 6 Voeten
- 7 Bodem plank



Regał przyścienny

- 1 Szyld z logo podświetlany
- 2 Osłony boczne
- 3 Szuflada w podstawie
- 4 Wspornik pionowy
- 5 Panel wystawienniczy
- 6 Wspornik podstawy
- 7 Półka dolna



Faliállvány

- 1 Világítótest
- 2 Oldal panelek
- 3 Basis fiókok
- 4 Állványok
- 5 Bemutató modulok
- 6 Basis lábazat
- 7 Basis fedlap



Expositor de parete

- 1 Sinal luminos
- 2 Painéis laterais
- 3 Base com gaveta
- 4 Coluna
- 5 Módulo expositor
- 6 Suporte
- 7 Estante base



Εκθετήριο τοίχου

- 1 Φωτεινή επιγραφή
- 2 Πλευρικά
- 3 Συρτάρι βάσης
- 4 Κατακόρυφο
- 5 Εκθετήριο
- 6 Στήριγμα
- 7 Ράφι βάσης

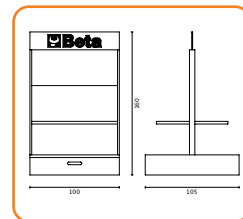
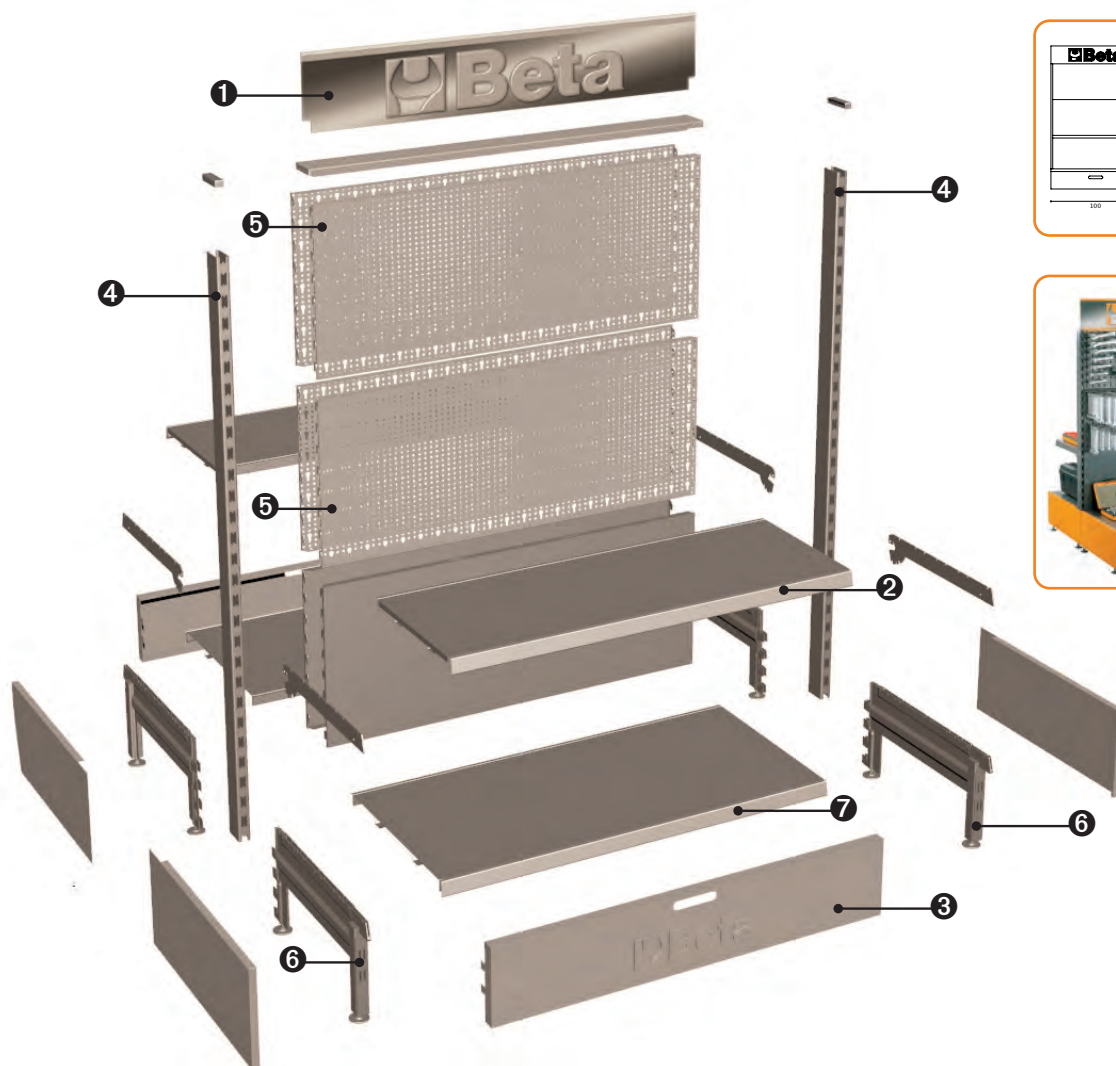

Espositore gondola

- 1 Crowner bifacciale
- 2 Ripiano parete
- 3 Frontalino base
- 4 Montante
- 5 Modulo espositivo
- 6 Piede base
- 7 Ripiano base



Gondola display

- 1 Double-faced crowner
- 2 Wall shelf
- 3 Base front
- 4 Upright
- 5 Display module
- 6 Support
- 7 Base shelf



Présentoir gondole

- 1 Crowner double face
- 2 Étagère murale
- 3 Façade de base
- 4 Montant
- 5 Module d'exposition
- 6 Piètement
- 7 Étagère de base



Expositor gondola

- 1 Crowner bifacial
- 2 Estante de pared
- 3 Carátula base
- 4 Montante
- 5 Módulo expositivo
- 6 Pie base
- 7 Estante base



Gondelaussteller

- 1 Doppelseitiger Crowner
- 2 Wandbord
- 3 Basis-Stirnteil
- 4 Ständer
- 5 Ausstellungsmodul
- 6 Basisfuß
- 7 Basisbord



"Gondel" vloer display

- 1 Top indicatie
- 2 Achterpaneel
- 3 Plank
- 4 Ständer
- 5 Ausstellungsmodul
- 6 Basisfuß
- 7 Basisbord



Regał wolnostojący

- 1 Szyld dwustronny z logo
- 2 Półka wisząca
- 3 Osłona przednia podstawy
- 4 Wspornik pionowy
- 5 Panel wystawienniczy
- 6 Wspornik podstawy
- 7 Półka dolna



Bemutató gondola

- 1 Kétoldalt polc
- 2 Fali fedlap
- 3 Basis-homlokfal
- 4 Állványok
- 5 Bemutató modulok
- 6 Basis lábazat
- 7 Basis fedlap



Expositor gondola

- 1 Painel de dupla face
- 2 Estante de parede
- 3 Base frontal
- 4 Coluna
- 5 Módulo expositor
- 6 Suporte
- 7 Estante base



Εκθετήριο Γόνδολα

- 1 Πινακίδα διπλής όψης
- 2 Ράφι τοίχου
- 3 Μπροσινή βάση
- 4 Κατακόρυφο
- 5 Εκθετήριο
- 6 Στήριγμα
- 7 Ράφι Βάσης

C63E/W

063000010



Espositore per abbigliamento con predisposizione per calzature

- 1 Crowner bifacciale
- 2 barre abbigliamento
- 3 ripiani espositivi



Workwear and safety shoes display

- 1 Double-faced crowner
- 2 Clothes bar
- 3 Display shelf



Présentoir pour vêtements et chaussures

- 1 Crowner double face
- 2 2 Barre porte-vêtements
- 3 3 Étagère



Expositor para prendas con predisposición para calzado

- 1 Crowner bifacial
- 2 2 Barra para prendas de vestuario
- 3 3 Estante expositivo



Kleider- und Schuhständer

- 1 Doppelseitiger Crowner
- 2 2 Kleiderstange
- 3 3 Ausstellungsregal



Werkkleding en veiligheidsschoenen display

- 1 Indicatie top voor de bovenzijde van het display
- 2 2 Kleding drager
- 3 3 Displayplank



Regał wystawienniczy na buty i ubrania

- 1 Szyld dwustronny z logo
- 2 2 Wieszak na odzież
- 3 3 Półka



Munkaruha és védőcipő bemutatófal

- 1 Kétoldalt polc
- 2 2 Vállfartató rúd
- 3 3 Polcán



Expositor de roupa e calçado de segurança

- 1 Painel de dupla face
- 2 2 Barra para roupa
- 3 3 Prateleira expositora













Εκθετήριο δαπέδου για ρούχα εργασίας και υποδήματα ασφαλείας

- 1 Πινακίδα διπλής όψης
- 2 2 Κρεμάστρα ρούχων
- 3 3 Ράφι εκθετήριο

C63G/C

06300020



-  Espositore per calzature
-  Footwear display stand
-  Présentoir de chaussures
-  Expositor para calzado
-  Schuhständer
-  Schoenen verkoopstandaard voor
-  Regał wystawienniczy
-  Cipőállvány
-  Expositor para calçado de segurança
-  Εκθετήριο υποδημάτων

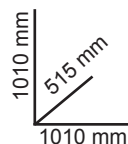

C63E/W

063000010

-  Espositore a manichino
-  Mannequin
-  Présentoir mannequin
-  Expositor maniquí
-  Kleiderständer
-  Werkkleding display
-  Manekin postaciowy
-  Állvány ruhák részére
-  Manequim
-  Μανεκέβ













1850 mm
450 mm
650 mm



1800 mm
540 mm
540 mm

C62EVC

062000200

-  Espositore per calzature, 8 posizioni
-  Footwear display stand, 8 positions
-  Présentoir de chaussures, 8 emplacements
-  Expositor para calzado, 8 posiciones
-  Schuhständer, 8 Positionen
-  Schoenen verkoopstandaard voor, 8 modellen
-  Regał wystawienniczy na 8 modeli butów
-  Cipőállvány, 8 állítási lehetőség
-  Expositor para calçado de segurança, 8 posições
-  Εκθετήριο υποδημάτων, 8 θέσεων



- | | |
|--|--|
|  Codici espositori lineari vuoti |  Lineare code voor lege displays |
|  Linear empty display codes |  Kody zestawów regałów bez wyposażenia |
|  Codes des présentoirs linéaires vides |  Lineáris üres állványok cikkszámja |
|  Códigos de expositores lineales vacíos |  Códigos de expositores lineares vazios |
|  Artikelnummern für leere Linearständer |  Κωδικοί για γραμμικά άδεια εκθετήρια |

 **Beta**

068000001	1 m
068000002	2 m
068000003	3 m
068000004	4 m
068000005	5 m
068000006	6 m
068000007	7 m
068000008	8 m
068000009	9 m
068000010	10 m
068000011	11 m
068000012	12 m
068000013	13 m

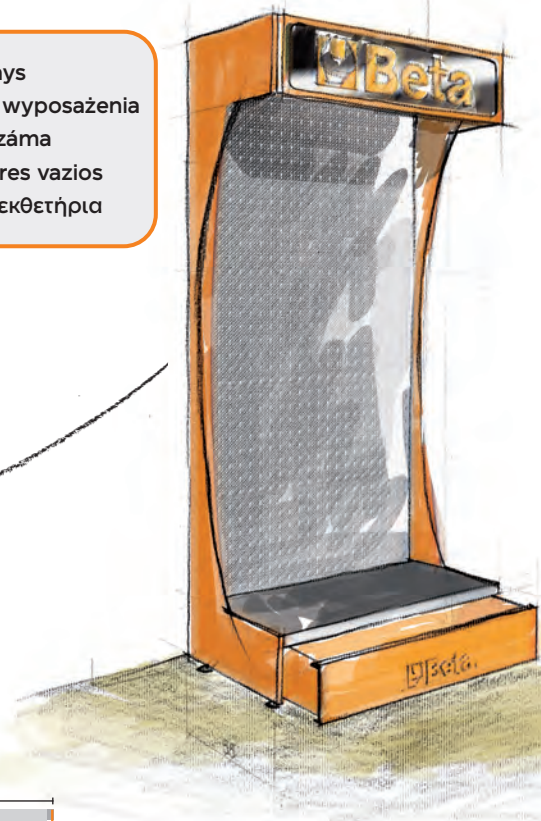

 **Robur**

088000001	1 m
-----------	-----













 **Beta**

068000051	1 m
068000052	2 m
068000053	3 m
068000054	4 m





SHOP in Shop

-  Progetta il tuo corner Beta
-  Build your Beta corner
-  Construisez votre corner Beta
-  Construye tu corner Beta
-  Schaffen Sie Ihren Beta Corner
-  Ontwerp je eigen presentatie
-  Zbuduj swoją ekspozycję Beta
-  Készítsd el a saját Beta sarkodat
-  Configure o seu espaço Beta
-  ΦΤΙΑΞΕ ΤΗ ΔΙΚΗ ΣΟΥ ΓΩΝΙΑ ΒΕΤΑ

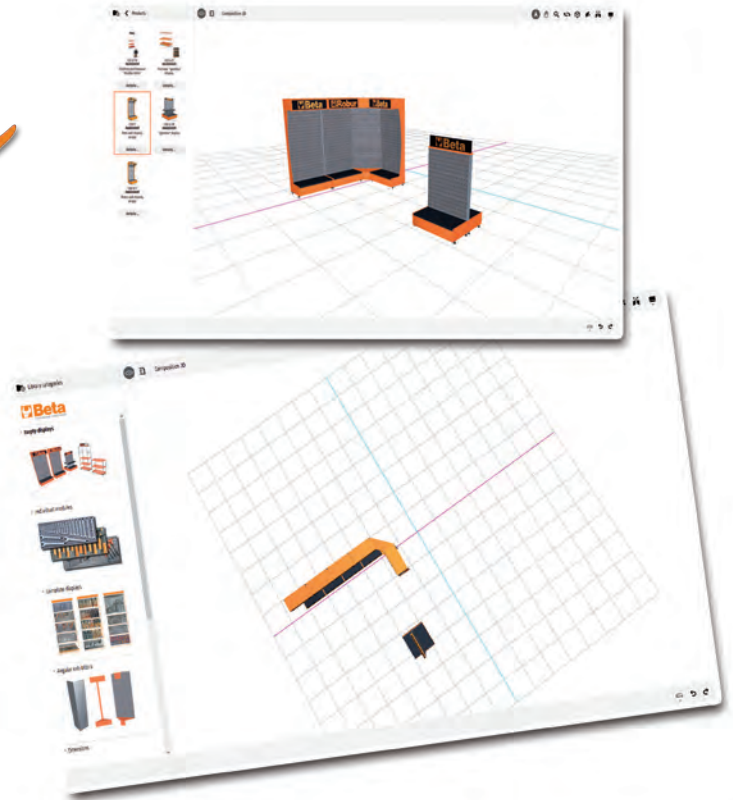





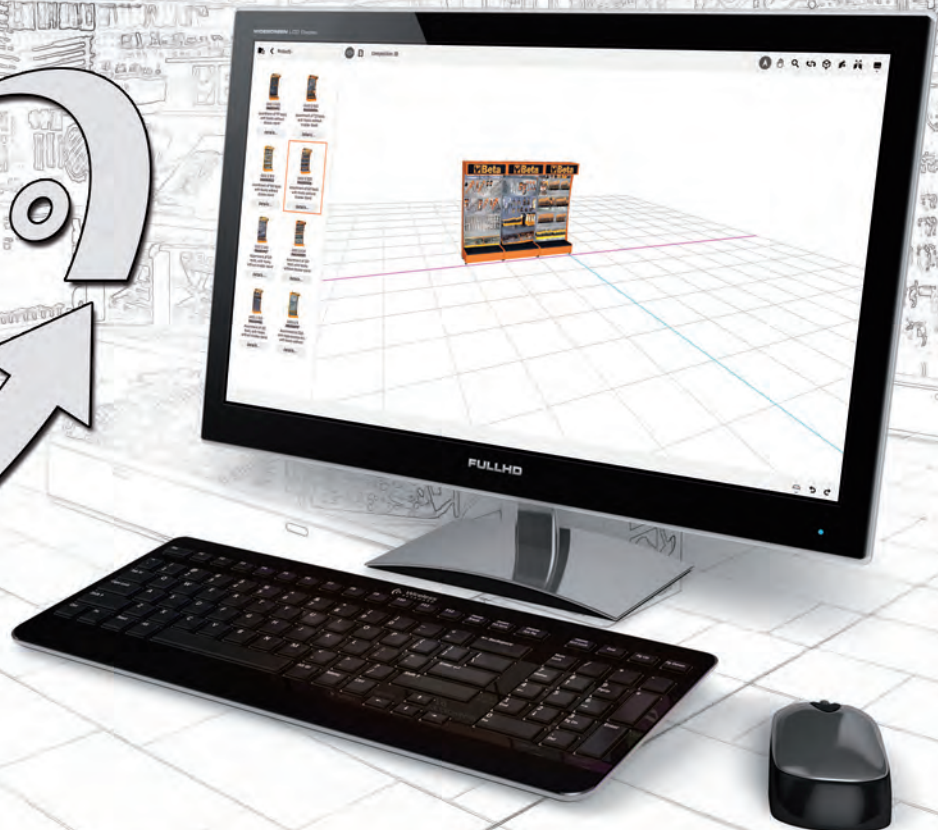

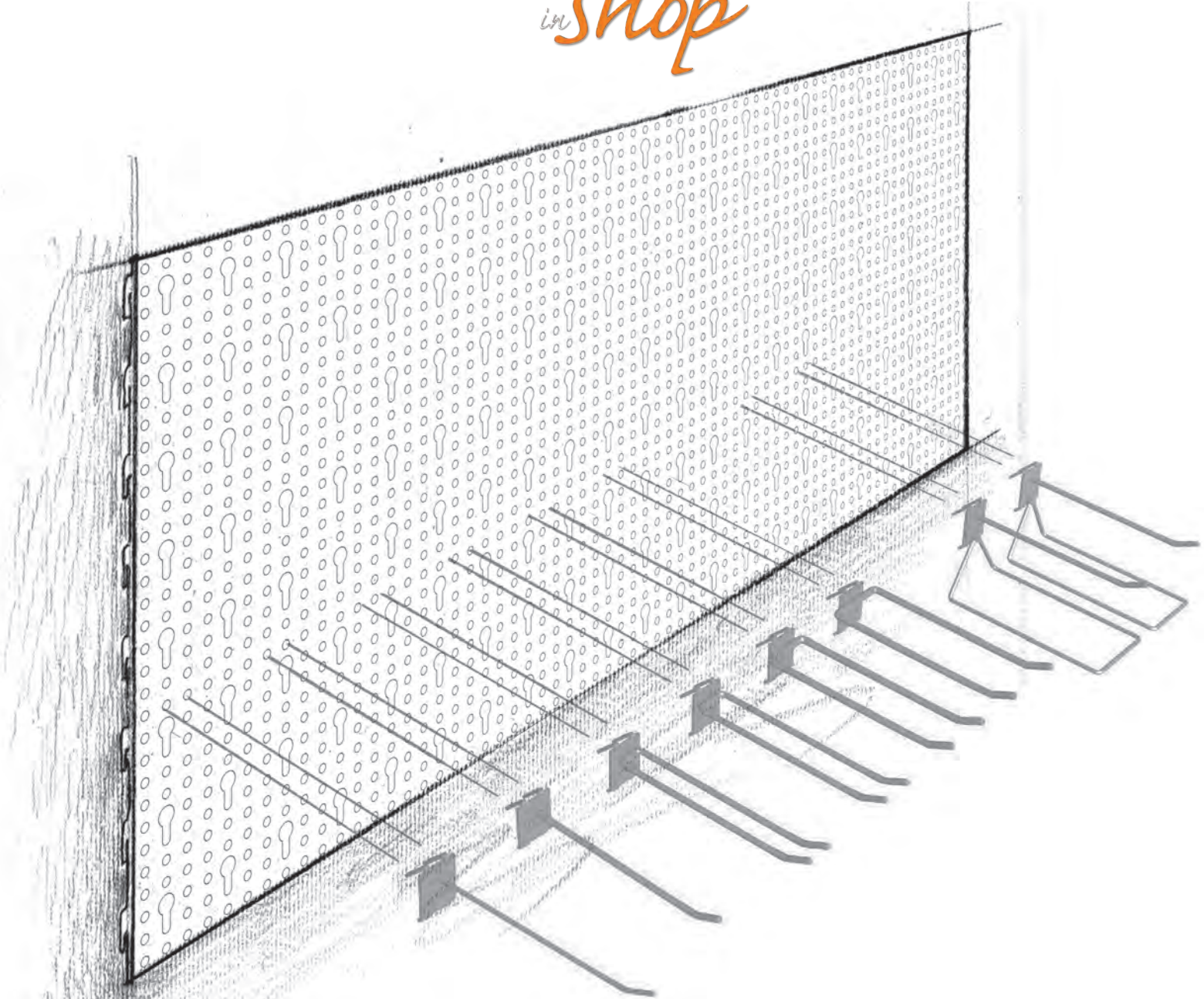



www.beta-tools.com/beta/3d/



360°
view















- PROPOSTE ESPOSITIVE: MODULI SINGOLI** 
- DISPLAY SUGGESTIONS: INDIVIDUAL MODULES** 
- PROPOSITIONS D'EXPOSITION: MODULES SIMPLES** 
- PROPUESTAS EXPOSITIVAS: MÓDULOS INDIVIDUALES** 
- AUSSTELLUNGSANGEBOTE: EINZELMODULE** 
- DISPLAY SUGGESTIES: INDIVIDUELE MODULES** 
- PROPOZYCJE EKSPOZYCJI: POJEDYNCZE MODUŁY** 
- ÁLLVÁNY AJÁNLATOK: EGYEDI MODULOK** 
- SUGESTÕES DE EXPOSITORES: MÓDULOS INDIVIDUAIS** 
- ΠΡΟΤΑΣΕΙΣ ΠΡΟΒΟΛΗΣ: ΑΥΤΟΝΟΜΕΣ ΜΟΝΑΔΕΣ** 



-  Legenda
-  Legend
-  Légende
-  Leyenda
-  Zeichenerklärung
-  Legenda
-  Opis
-  Jelmagyarázat
-  Legenda
-  Υπόμνημα













-  Gli assortimenti comprendono utensili + ganci
-  Assortments include tools + hooks
-  Les compositions sont constituées d'outils + crochets
-  Los surtidos incluyen herramientas + ganchos
-  Die Sortimente beinhalten Werkzeuge + Haken
-  Een assortiment bestaat uit gereedschappen + haken
-  Moduły składają się wyłącznie z narzędzi i elementów mocujących
-  Ajánlatok tartalmazzák a szerszámokat + kampókat
-  Jogos incluem ferramentas + ganchos
-  Οι συλλογές περιλαμβάνουν εργαλεία + γάντζους



-  Numero utensili
-  Number of tools
-  Nombre d'outils
-  Número de herramientas
-  Anzahl der werkzeuge
-  Aantal Gereedschappen
-  Liczba narzędzi
-  Szerszámok száma
-  Número De ferramentas
-  Πλήθος εργαλείων



-  Numero ganci
-  Number of hooks
-  Nombre de crochets
-  Número de ganchos
-  Anzahl der haken
-  Aantal haken
-  Liczba haków
-  Kampók száma
-  Número de ganchos
-  Πλήθος γάντζων

-  Pannello non incluso
-  Panels not included
-  Panneaux non fournis
-  Paneles no incluidos
-  Paneel nicht mitgeliefert
-  Exclusief de wandpanelen
-  Panele nie wchodzą w skład zestawów
-  Panel nélkül szállítva
-  Painéis não incluídos
-  Δεν περιλαμβάνονται πίνακες

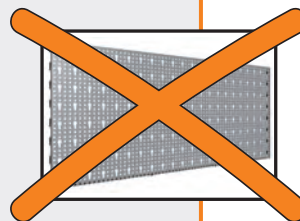

6600 M/14



066000014

154

27

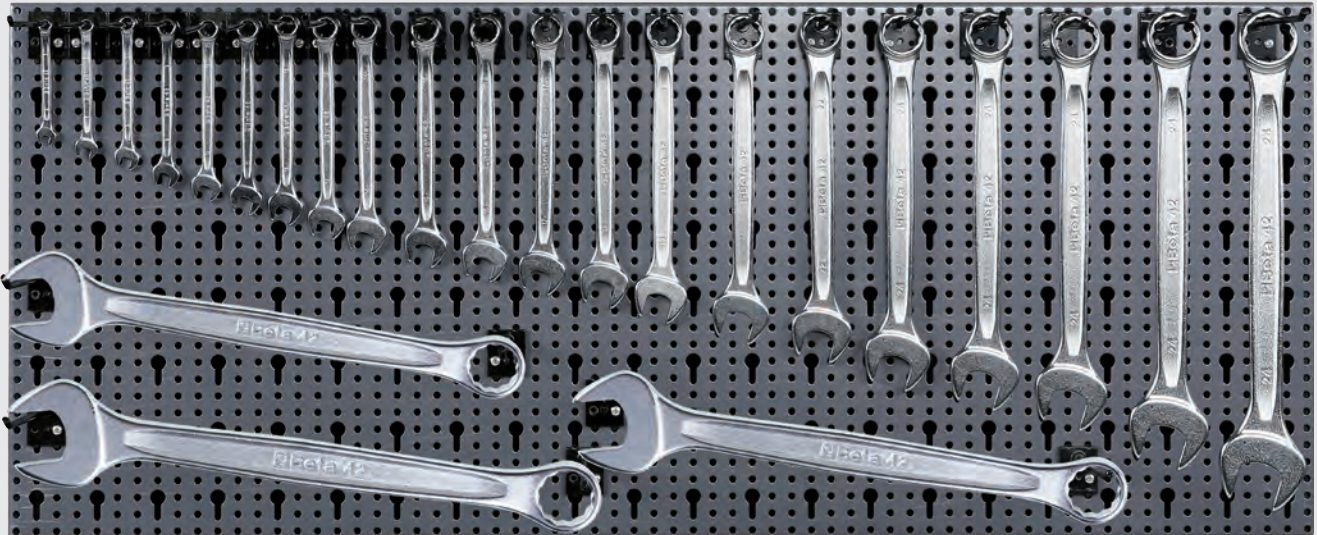
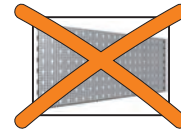



42NEW		N°
	6x6 mm	10
	7x7 mm	
	8x8 mm	
	9x9 mm	
	10x10 mm	
	11x11 mm	
	12x12 mm	
	13x13 mm	
	14x14 mm	5
	15x15 mm	
	16x16 mm	
	17x17 mm	10
	18x18 mm	5
	19x19 mm	10
	21x21 mm	5
	22x22 mm	
	24x24 mm	
	27x27 mm	
	28x28 mm	2
	30x30 mm	3
	32x32 mm	
	36x36 mm	2
	38x38 mm	
	41x41 mm	

6600 M/22

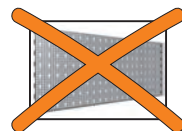

066000022



			N°
55		6x7 mm	10
		8x9 mm	
		10x11 mm	
		12x13 mm	
		14x15 mm	
		16x17 mm	
		18x19 mm	
		20x22 mm	5
		21x23 mm	
		24x26 mm	
		25x28 mm	
		27x29 mm	
		30x32 mm	
		32x36 mm	2
34x36 mm			
36x41 mm			
41x46 mm			

6600 M/27



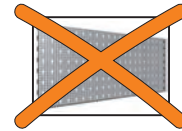

066000027

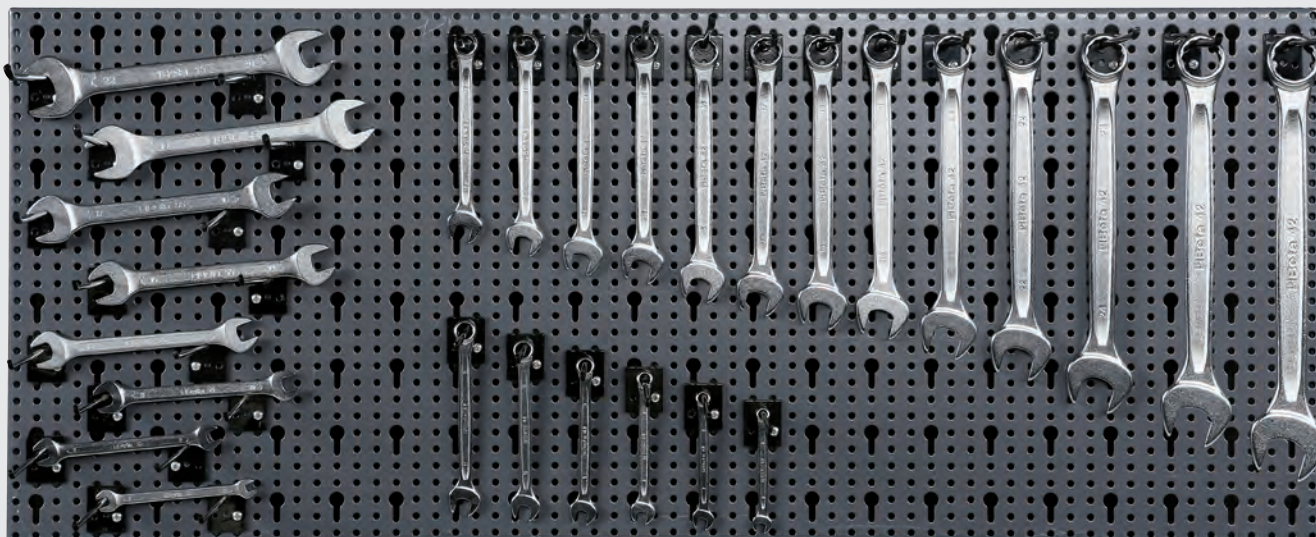
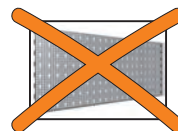

52			N°
		17 mm	5
		24-27-30	2
		32-36-38	
		41-46-50-55 mm	



		N°
42NEW		6x6 mm 5
		7x7 mm 10
		8x8 mm 5
		9x9 mm 10
		10x10 mm 5
		11x11 mm 10
		12x12 mm 5
		13x13 mm 10
		14x14 mm 5
		15x15 mm 10
		16x16 mm 5
		17x17 mm 10
		18x18 mm 5
		19x19 mm 10
		22x22 mm 5
24x24 mm 8		
27x27 mm 5		
30x30 mm		
32x32 mm		
55		6x7 mm 5
		8x9 mm 10
		10x11 mm 5
		12x13 mm 10
		14x15 mm 5
		16x17 mm 10
		18x19 mm 5
20x22 mm		

6600 M/33



066000033

37

14

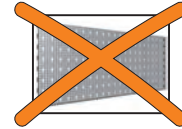

		N°
111		5
		3
		3
		2
111G		3
		2
186		2

6600 M/40



066000040

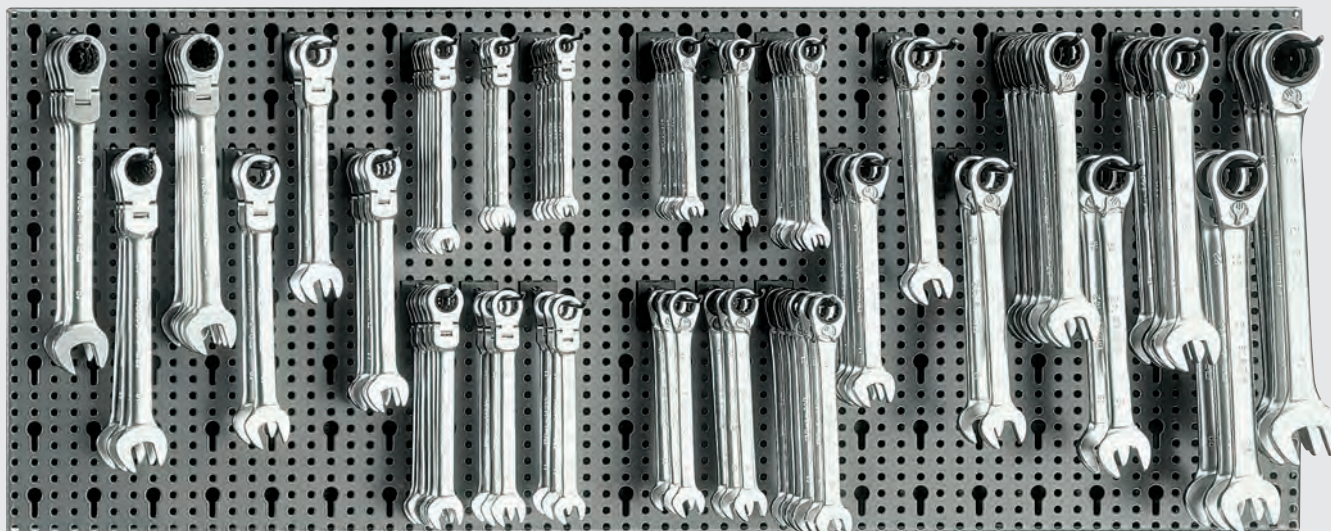
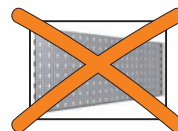

		N°
142		8 mm 6
		9 mm 3
		10 mm 6
		11-12 mm 3
		13 mm 6
		14 mm 4
		15-16 mm 2
		17 mm 6
		18 mm 2
		19 mm 4
		22-24 mm 3
142SN		8 mm 6
		9 mm 3
		10 mm 6
		11-12 mm 3
		13 mm 6
		14 mm 4
		15-16 mm 2
		17 mm 6
18 mm 2		
19 mm 4		

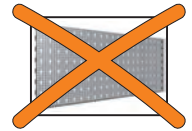

		N°
141		8 mm 6
		9 mm 3
		10 mm 6
		11-12 mm 3
		13 mm 6
		14 mm 4
		15-16 mm 2
		17 mm 6
		18 mm 2
		19 mm 4
192/S2		8x10 4
		12x13
		16x17
		18x19 mm
195		8x10 2
		12x13
		14x15
		16x18
		17x19 mm

6600 M/44



066000044

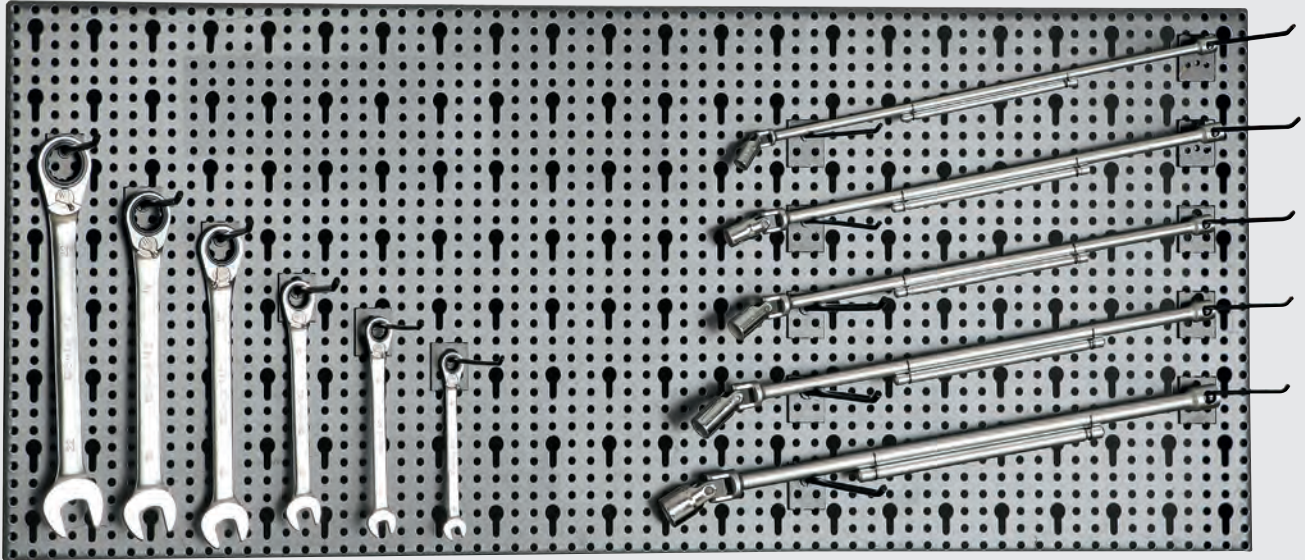
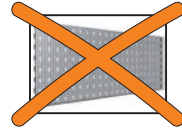



		N°
142		8 mm 3
		10 mm 5
		13 mm
		17 mm 4
		19 mm 3
		22 mm 5
952		8 mm 5
		10 mm
		12 mm
		13 mm
		17 mm 3

6600 M/47

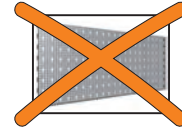

066000047



99			N°
		12-14	5
		16-18-20	
		22-25-28	
		30-32	
		34-36-38	
		40-42	
		45-50	
		52-55-58	
		62-65	
		68-70-75 mm	
		80-85-90	
		92-95	3
		98-100	
		105-110-115	
120-125-130 mm			

6600 M/51



066000051

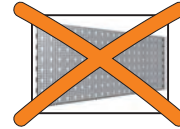

		N°
96T ○		2 mm 5
		2,5-3-4 10
		5-6 mm 5
		7-8-10 mm 5
96/BG7 ○		2,5-3-4-5 2 6-8-10 mm
96/SC9 ○		1,5-2-2,5 5 3-4-5-6-8 10 mm
96ST6 ○		2,5-3-4-5 3 6-8 mm
96BPC/ SC9 ○		1,5-2-2,5 5 3-4-5-6-8 10 mm
951 ○		2 mm 5
		2,5-3-4-5-6 mm 10
		8-10 mm 5

6600 M/52



066000052

176

25

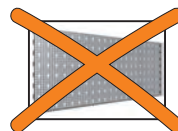

		N°
96T ○		2-2,5-3 4-5-6-7 8-10 mm 5
96/SC9 ○		1,5-2-2,5 3-4-5-6 8-10 mm 5
97TTX ⊙		T8-T9-T10 T15-T20-T25 5
		T27-T30-T40 5
		T45 3
		T50 2
97BTX/ SC8 ⊙		T9-T10-T15 T20-T25 T27-T30-T40 3
97RTX/ SC8 ⊙		T9-T10-T15 T20-T25-T27 T30-T40 3



150

25

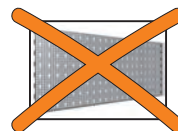

		N°
97TX/ BG8 ⊙		T9-T10 2 T15-T20 T25-T27 T30-T40
97TX/ST8 ⊙		T9-T10 3 T15-T20 T25-T27 T30-T40
97BTX/ SC8 ⊙		T9-T10 3 T15-T20 T25-T27 T30-T40
97TTX ⊙		T8-T9 3
		T10-T15
		T20-T25
		T27-T30 5
		T40
		T45 3
		T50 2
97RTX/ SC8 ⊕		T9-T10 3 T15-T20 T25-T27 T30-T40
951TX ⊙		T9-T10 3 T15-T20 T25-T27 T30-T40

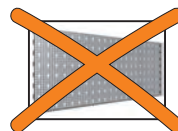

		N°
96T ○		2-2,5 mm 5
		3-4-5 mm 10
		6 mm 5
96/SC9 ○		1,5-2-2,5 5
		3-4-5-6
		8-10 mm
96BPC/ SC9 ○		1,5-2-2,5 10
		3-4-5-6
		8-10 mm
951 ○		2,5-3-4-5 5
		6-8 mm
111		200 4
		250 mm
		300 mm 2

6600 M/61



066000061

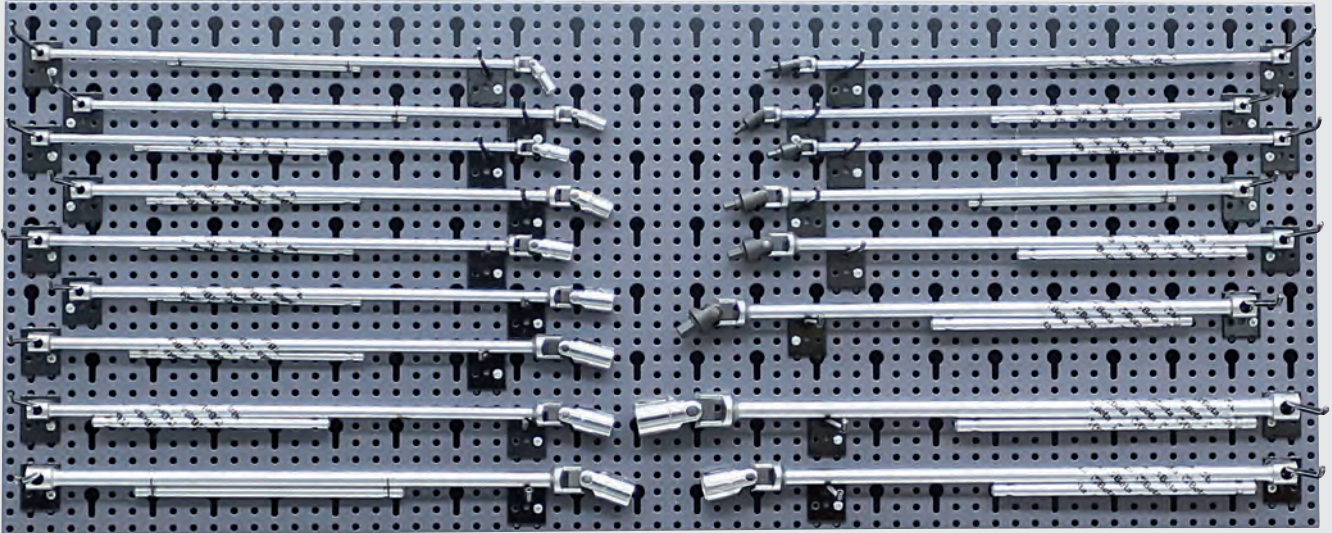
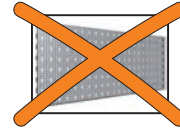



		N°
952 ○		6 mm 5
		7 mm
		8 mm
		10 mm 5
		11 mm 3
		12 mm 5
		13 mm
		14 mm 3
		15 mm
		17 mm
	19 mm	
953 ○		3 mm 5
		4 mm
		5 mm
		6 mm
		8 mm 3
		10 mm

6600 M/62

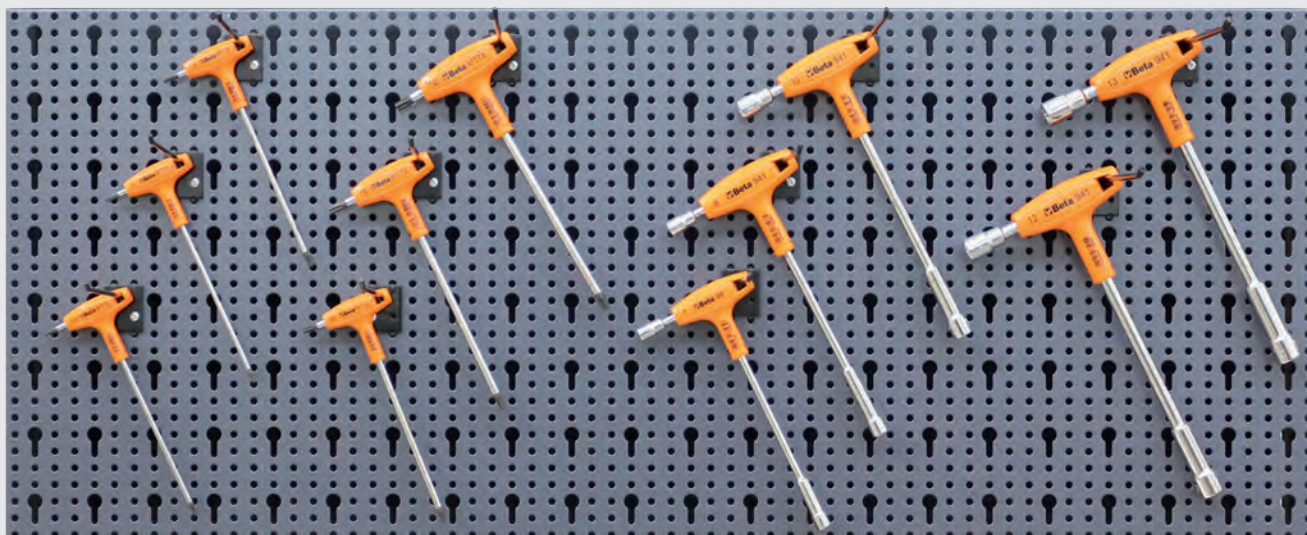
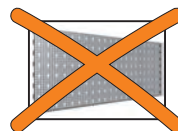

066000062



97TTX ⊕		T10-T15 T20-T25 T30-T40	N° 3
941 ○		7x7 8x8 10x10 12x12 13x13 mm	2

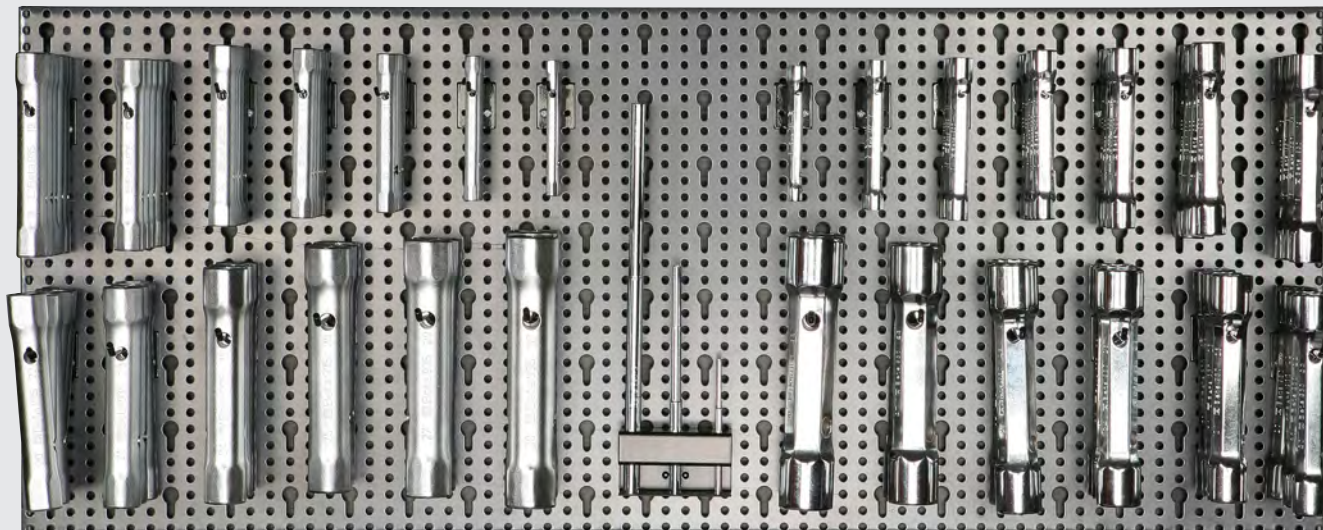
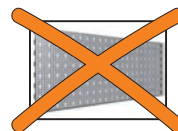

		N°
930 ○	○6x7	5
	8x9 mm	
	10x11-12x13	5
	14x15-16x17	
	18x19	
	20x22 mm	
935 ○	21x23	3
	24x26 mm	
	25x28-27x29	2
	30x32 mm	
	6x7-8x9 mm	5
	10x11 mm	
	12x13 mm	
	14x15 mm	
	16x17 mm	
	18x19 mm	
20x22 mm		
21x23 mm	3	
24x26 mm		
25x28 mm	2	
27x29 mm		
30x32 mm		

940/1		930-935: 2
		6÷13 mm
940/2		930-935: 2
		14÷22 mm
940/3		930-935: 2
		21÷32 mm

6600 M/73



066000073

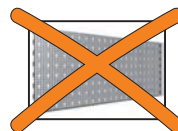

933 ○ ○		N°	
		6x6 mm	5
		7x7 mm	
		8x8 mm	
		9x9 mm	
		10x10 mm	
		11x11 mm	
		12x12 mm	
		13x13 mm	
		14x14 mm	3
		15x15 mm	
		16x16 mm	
		17x17 mm	
		18x18 mm	
		19x19 mm	
		20x20 mm	
21x21 mm			
22x22 mm	2		
24x24 mm			

6600 M/112



066000112

329

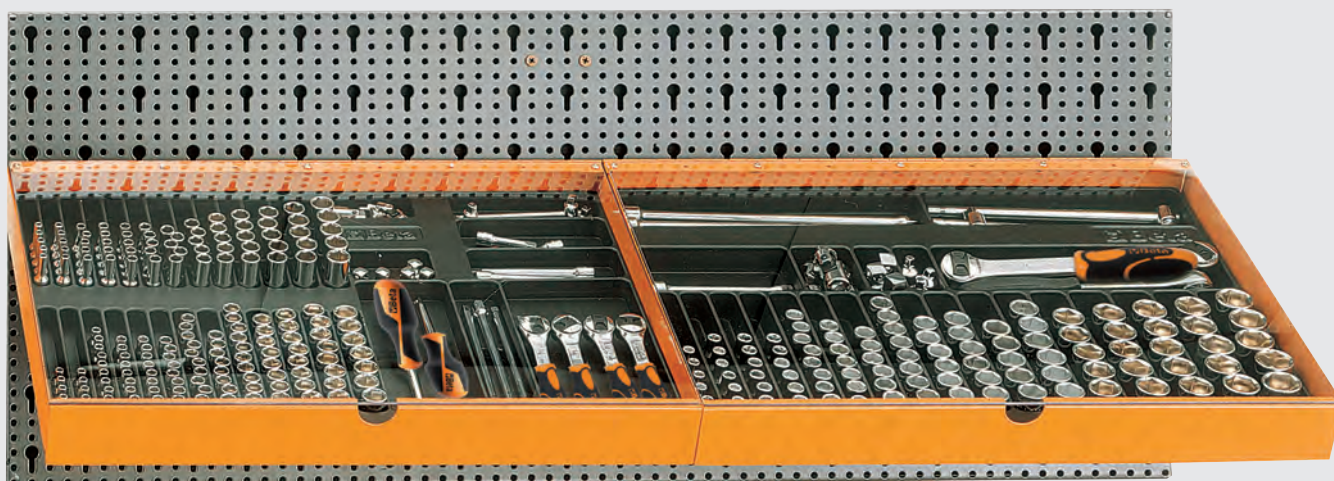
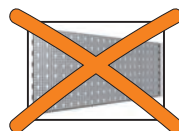

Code	Image	Dimensions	N°
900		4-4,5-5-5,5 6-7-8-9-10 mm	10
		11-12-13 mm	8
		14 mm	7
900L		4-4,5-5-5,5 6-7-8-9-10 11-12-13-14 mm	5
900/16		□1/4"x■3/8"	5
900/20		50 mm	3
900/20L		100 mm	3
900/21		150 mm	3

900/25			3
900BG/30		176 mm	2
900/42			3
900/55			5



Code	Image	Dimensions	N°
910A		6-7 mm	5
		8 mm	8
		9 mm	5
		10 mm	8
		11-12 mm	5
		13 mm	8
		14-15-16 mm	5
		17 mm	8
		18 mm	5
		19 mm	8
		20-21-22 mm	5

910/15		□3/8"x■1/4"	3
910/16		□3/8"x■1/2"	3
910/21		125 mm	2
910/22		250 mm	2
910/25			2
910/42			2
910/55			2

6600 M/116



066000116

306

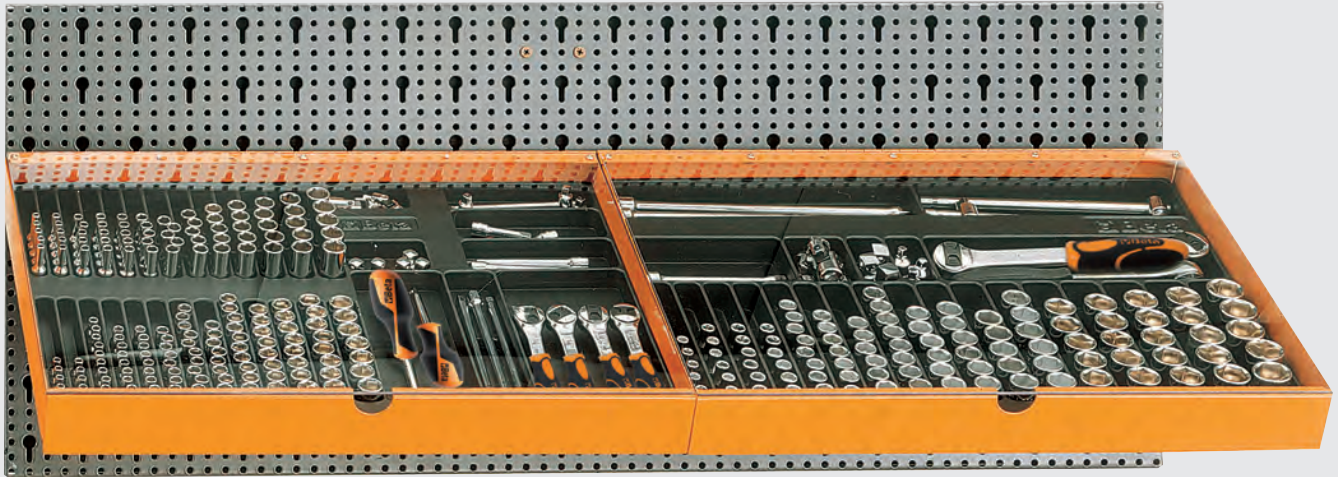
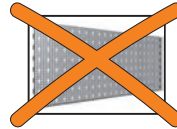

900 		4-4,5-5-5,5 6-7-8-9-10 mm	10
		11-12-13 mm	8
		14 mm	7
		4-4,5-5-5,5 6-7-8-9-10 11-12-13-14 mm	5
900L 		4-4,5-5-5,5 6-7-8-9-10 11-12-13-14 mm	5
900/16 		□1/4" x ■3/8"	5
900/20 		50 mm	3
900/20L 		100 mm	3
900/21 		150 mm	3

900/25 			N°	3
900BG /30 		176 mm		2
900/42 				3
900/55 				5



910B 		6-7 mm	4
		8 mm	5
		9 mm	4
		10 mm	6
		11-12 mm	5
		13 mm	6
		14-15-16 mm	4
		17 mm	6
		18-19-20	4
		21-22 mm	

910/15 		□3/8" x ■1/4"	N°	3
910/16 		□3/8" x ■1/2"		3
910/21 		125 mm		2
910/22 		250 mm		2
910/25 				2
910/42 				2
910/55 				2

6600 M/120



066000120

163

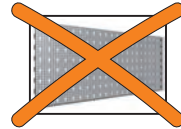

Code	Image	Dimensions	N°
920A 12"		8 mm	6
		9 mm	5
		10 mm	9
		11 mm	5
		12 mm	6
		13 mm	9
		14-15 mm	8
		16 mm	6
		17 mm	8
		18-19 mm	7
		20-21 mm	5
		22 mm	6
		23-24-25	5
		26-27-28	5
29 mm	6		
30-32 mm	4		
920/15 12"		□1/2"x□3/8"	2
920/16 12"		□1/2"x□3/4"	2
920/20 12"		75 mm	2
920/21 12"		125 mm	2

Code	Image	Dimensions	N°
920/22 12"		255 mm	2
920/25 12"			2
920/42 12"			2
920/50 12"			2

Code	Image	Dimensions	N°
920/55 12"			4

6600 M/125



066000125

133

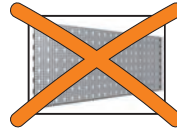

920B 12" ○		8 mm	4
		9 mm	3
		10 mm	8
		11 mm	3
		12 mm	4
		13 mm	8
		14-15 mm	6
		16 mm	4
		17 mm	8
		18 mm	6
		19 mm	8
		20-21 mm	3
		22 mm	6
		23 mm	3
		24 mm	6
25-26 mm	3		
27 mm	4		
28-29 mm	3		
30-32 mm	4		
920/15 12"		□1/2" x ■3/8"	2
920/16 12"		□1/2" x ■3/4"	2
920/20 12"		75 mm	2

920/21 12"		125 mm	2
920/22 12"		255 mm	2
920/25 12"			2
920/42 12"			2

920/50 12" 72			2
920/55 12" 72			4

6600 M/126







066000126

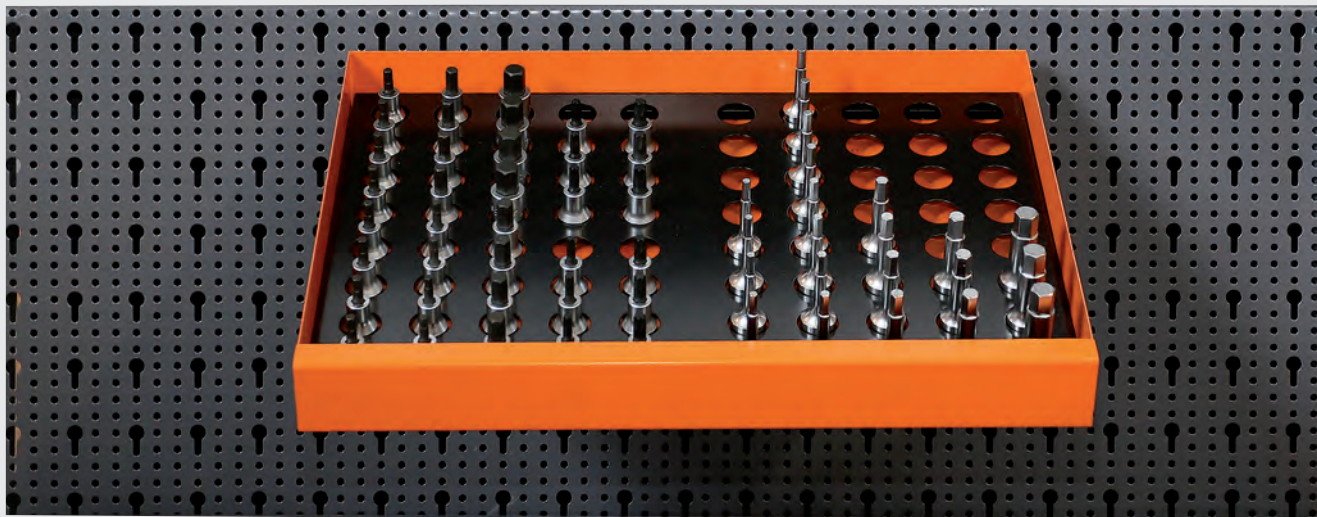
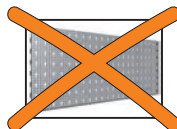

58



		N°
920PE 12° ○		5 mm 4
		6 mm 8
		8 mm 4
		10 mm
		14 mm
920ME 12° ○		5 mm 4
		6 mm 8
		8 mm 4
		10 mm 3
		14 mm
920TX 12° ⊙		T30 3
		T40
		T45
		T50

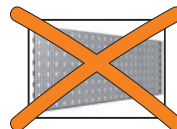

			N°
928A 		19-22 mm	4
		23 mm	2
		24 mm	6
		26 mm	2
		27 mm	6
		28 mm	4
		29 mm	2
		30-32 mm	6
		33-34 mm	4
		35 mm	2
		36 mm	6
		38-41	4
		46 mm	2
		50 mm	2
55-60 mm	4		
928/15 		□3/4"x1"	2
928/21 		200 mm	2
928/22 		380 mm	2

			N°
928/25 			2
928/42 		450 mm	2
928/55 		510 mm	2

6600 M/174



066000174

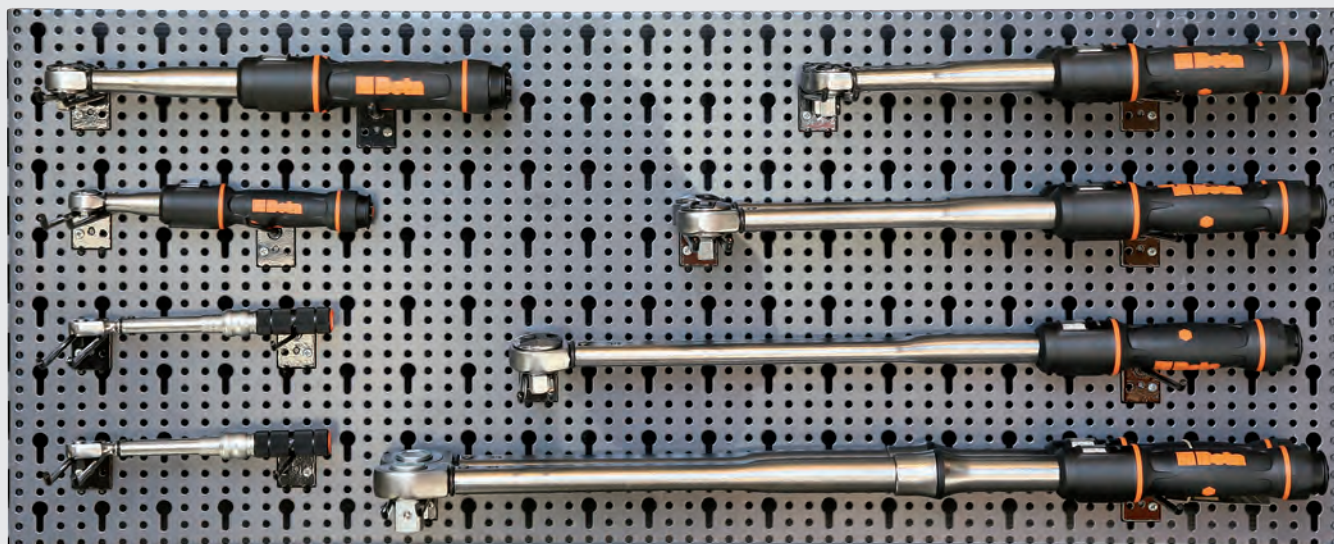
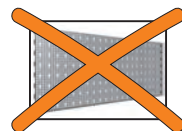

		N°
605E/5	 ■ 1/4" 1÷5 Nm	1
605E/10	 ■ 1/4" 2÷10 Nm	1
666N/2	 ■ 1/4" 5÷25 Nm	1
666N/5	 ■ 3/8" 10÷50 Nm	2

		N°
666N/10X	 ■ 1/2" 20÷100 Nm	2
666N/20	 ■ 1/2" 40÷200 Nm	2
666N/30	 ■ 1/2" 60÷300 Nm	2
667N/40	 ■ 3/4" 80÷400 Nm	2

6600 M/175



066000175

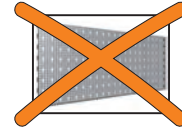

		N°
605E/5	 ■ 1/4" 1÷5 Nm	1
605E/10	 ■ 1/4" 2÷10 Nm	1
665/6	 ■ 3/8" 10÷60 Nm	2
665/10	 ■ 3/8" 20÷100 Nm	2

		N°
665/10X	 ■ 1/2" 20÷100 Nm	2
665/20	 ■ 1/2" 40÷200 Nm	2
665/30	 ■ 1/2" 60÷300 Nm	2

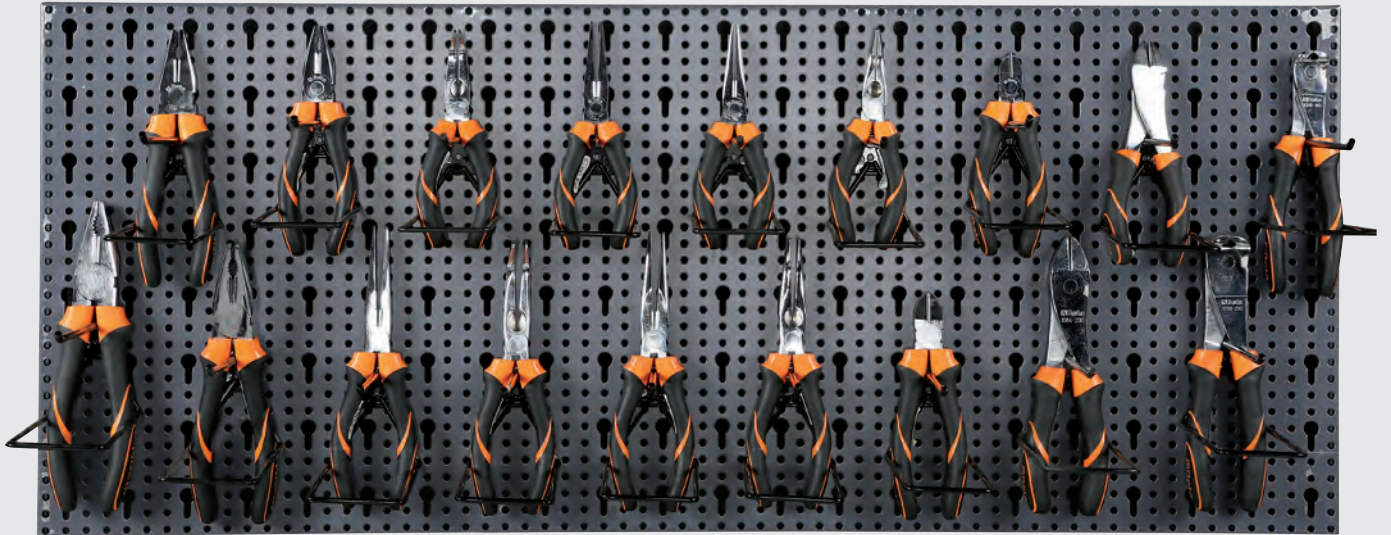
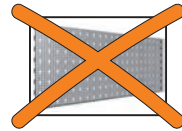

		N°
1082BM	140 mm	3
	160 mm	5
1084BM	160 mm	5
	200 mm	3
1088BM	160 mm	5
	200 mm	3
1150BM	160 mm	5
	180 mm	
	200 mm	
	220 mm	3

		N°
1162BM	160 mm	5
	200 mm	3
1164BM	160 mm	5
	200 mm	3
1166BM	160 mm	5
	200 mm	3
1168BM	160 mm	5
	200 mm	3

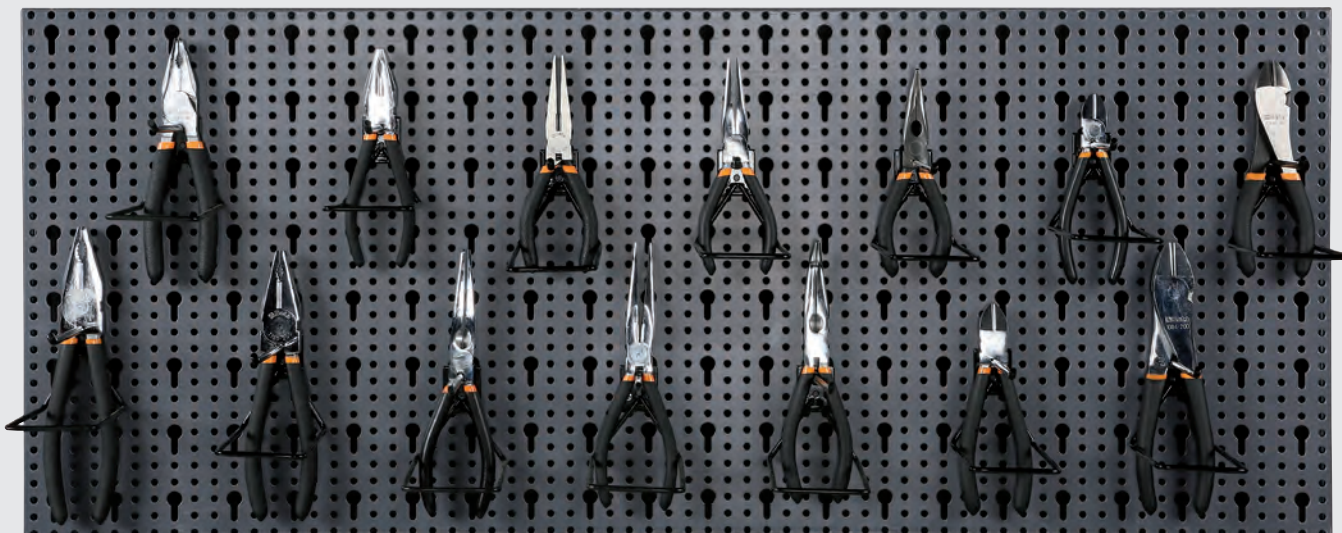
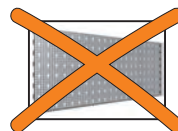

Model	Image	Lunghezza (mm)		N°
		140 mm	160 mm	
1082G		140 mm	3	
		160 mm	5	
1084G		160 mm	5	
		200 mm	3	
1150G		160 mm	5	
		180 mm		
		200 mm		
		220 mm	3	

Model	Image	Lunghezza (mm)		N°
		160 mm	200 mm	
1162G		160 mm	5	
		200 mm	3	
1166G		160 mm	5	
		200 mm	3	
1168G		160 mm	5	
		200 mm	3	



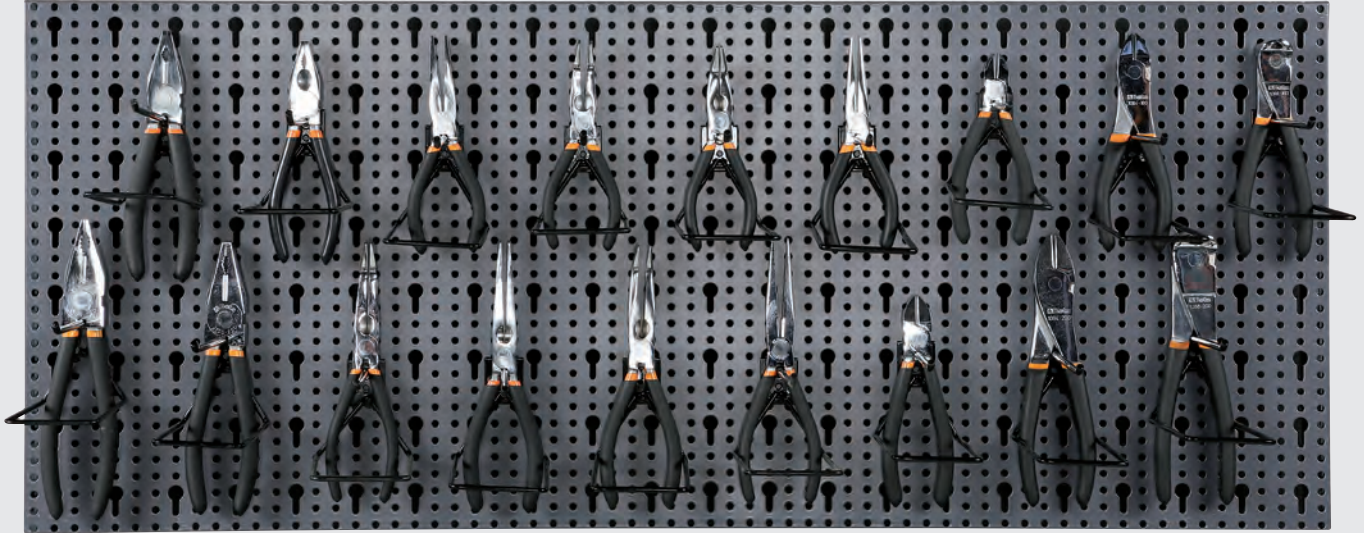
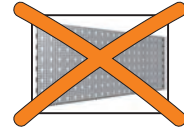

			N°
1082		140 mm	3
		160 mm	5
1084		160 mm	5
		200 mm	3
1088		160 mm	5
		200 mm	3
1150		160 mm	5
		180 mm	
		200 mm	
		220 mm	3

			N°
1162		160 mm	5
		200 mm	3
1164		160 mm	5
		200 mm	3
1166		160 mm	5
		200 mm	3
1168		160 mm	5
		200 mm	3



58

14

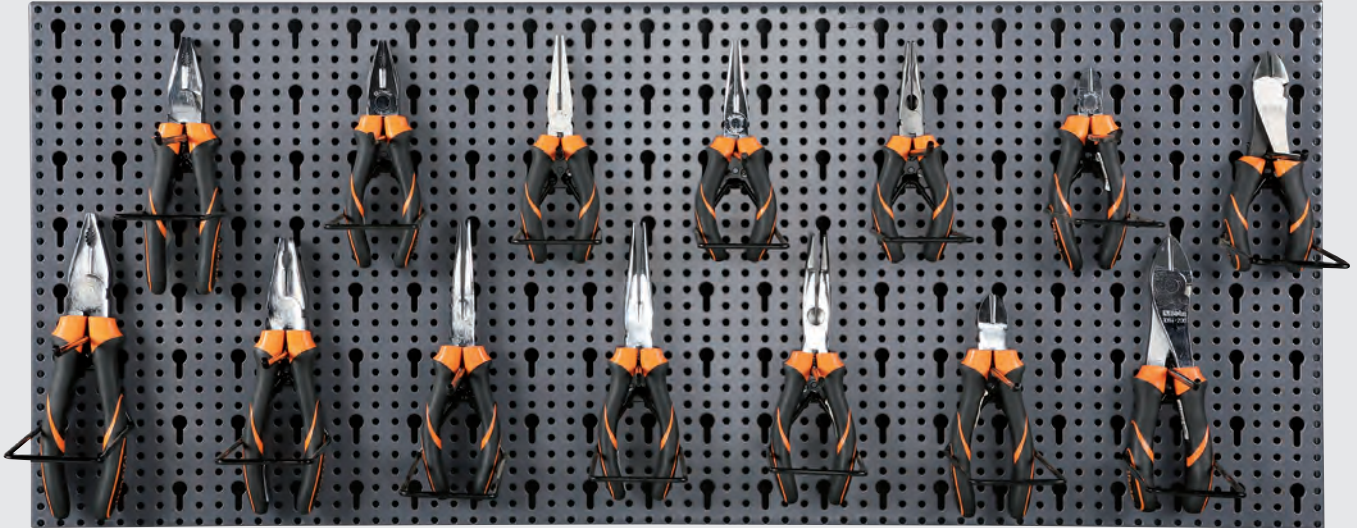
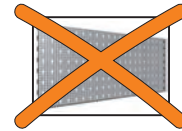

Model	Lengths	N°
1082GBM	140 mm	3
	160 mm	5
1084GBM	160 mm	5
	200 mm	3
1150GBM	160 mm	5
	180 mm	3
	200 mm 220 mm	3

Model	Lengths	N°
1162GBM	160 mm	5
	200 mm	3
1166GBM	160 mm	5
	200 mm	3
1168GBM	160 mm	5
	200 mm	3



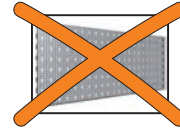

		N°
1032 ☉	140 mm 180 mm 225 mm	5
1033 ☉	225 mm	2
1034 ☉	130 mm 170 mm 210 mm	5
1036 ●	140x0,9 mm 140x1,3 mm 175 mm 225 mm	5
1038 ●	135x0,9 mm 135x1,3 mm 175 mm 220 mm	5
1037 ●	175 mm 225 mm	2

		N°
1039 ☉ ●	150 mm	2

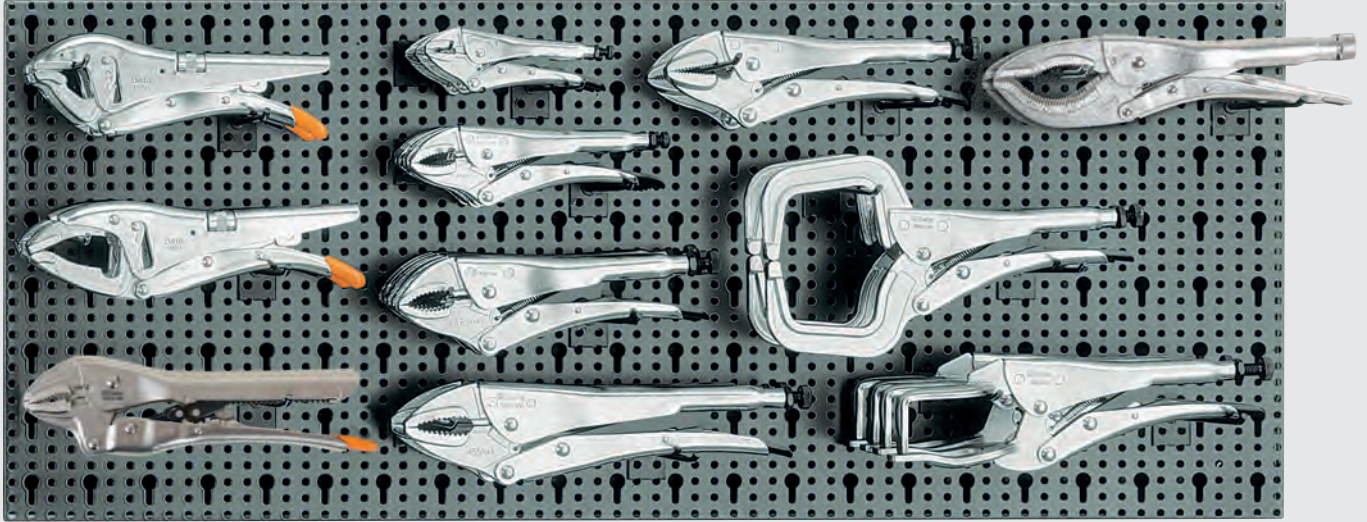
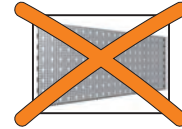

		N°
1050	220 mm	2
1051	255 mm	2
1052	140 mm 190 mm 240 mm 300 mm	3 6 2 2
1054	235 mm	2
1055	270 mm	2
1057A	240 mm	2

		N°
1060	280 mm	2
1062	290 mm	2

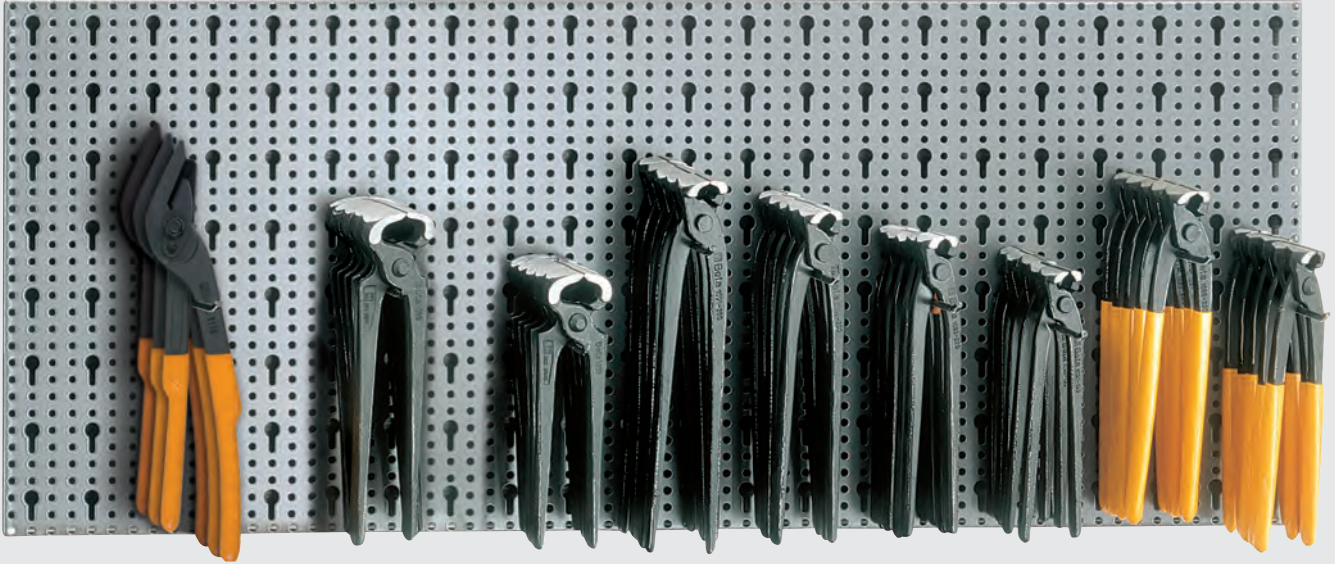
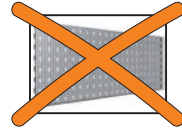

		N°
1096	200 mm 250 mm	5
1098	190 mm 220 mm 250 mm 280 mm	5
1098PL	200 mm 250 mm	5
1118	310 mm	3

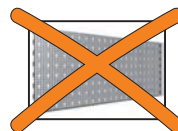

		N°
1032 ⊙	140 mm 180 mm	5
1034 ⊙	130 mm 170 mm	5
1036 ●	140x1,3 mm 175 mm	5
1038 ●	135x1,3 mm 175 mm	5
1048	250 mm	5
1052	240 mm	3

		N°
1082	140 mm 160 mm	5 3
1088BM	160 mm	5
1150BM	180 mm 200 mm	5
1162BM	160 mm	5

		N°
1164BM	160 mm	5
1166BM	160 mm	5
1168BM	160 mm	5

6600 M/253



066000253

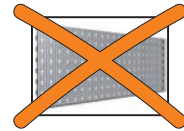

		N°
1032 ☉	180 mm	5
1034 ☉	170 mm	5
1036 ●	175 mm	5
1038 ●	175 mm	5
1047	240 mm	4
1048	250 mm	5

		N°
1052	240 mm	4
1082BM	160 mm	5
1084BM	160 mm	3
1150BM	180 mm 200 mm	5
1166BM	160 mm	5
1741B		4

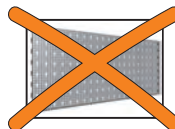

1293BX/DA



1293INOX/D8 3X



		N°	
1293 ●		3x75 mm	7
		3,5x100 mm	
		4x100 mm	
		4x125 mm	
		5,5x100 mm	
		5,5x150 mm	
		6,5x150 mm	6
	8x150 mm	3	
	10X200 mm	2	
1290N ●		4x30 mm	3
		6,5x30 mm	
1292 ●		PH0x60 mm	7
		PH1x80 mm	
		PH2x100 mm	6
	PH3x150 mm	5	
1292N +		PH1x30 mm	3
		PH2x30 mm	

		N°	
1290 INOX ●		2,5x50	1
		3x75 mm	
		4x100 mm	
		5,5x150 mm	
		6,5x150 mm	
1292 INOX +		PH0x60 mm	1
		PH1x80 mm	
		PH2x100 mm	

6600 M/315



066000315

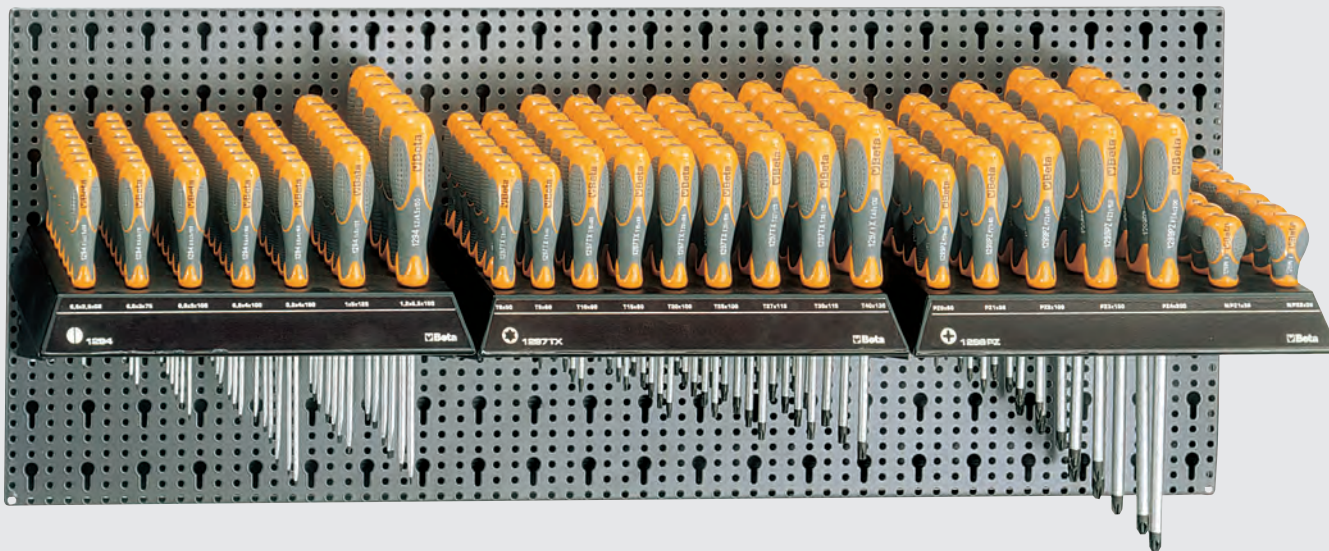
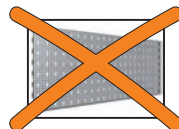

1293BX/DD



1293BX/DF



1293BX/DE



1294			N°
	2,5x60 mm	7	
	3x75 mm		
	3x100 mm		
	4x100 mm		
	4x150 mm		
	5x125 mm		
	6,5x150 mm	6	

1297TX			N°
	T6-T8-T10	7	
	T15-T20-T25		
	T27-T30	6	
	T40	5	

1299PZ			N°
	PZ0	7	
	PZ1		
	PZ2	6	
	PZ3	5	
	PZ4		
1299N/PZ			6
	PZ1		
	PZ2		

6600 M/320



066000320

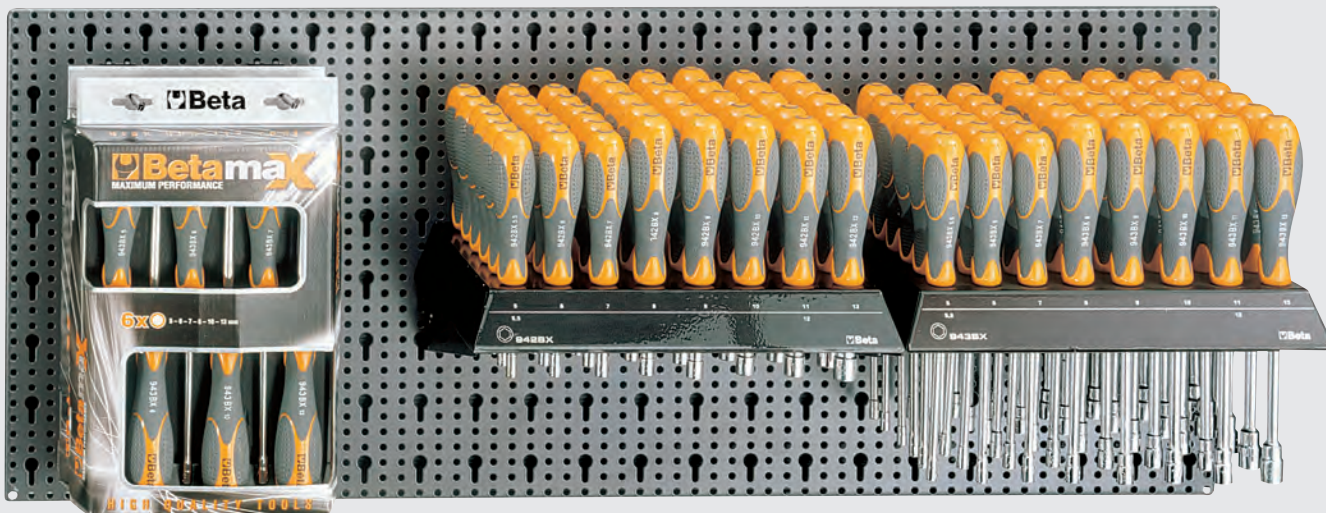
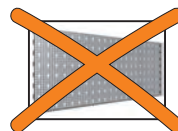

943BX/D6 2X



942BX/DG



943BX/DG



943BX		N°
	5 mm	1
	6 mm	
	7 mm	
	8 mm	
	10 mm	
	13 mm	

942BX		N°
	5-5,5 mm	3
	6-7 mm	6
	8-9-10-13 mm	5
	11 mm	2
	12 mm	3

943BX		N°
	5-5,5 mm	3
	6-7 mm	6
	8-9-10-13 mm	5
	11 mm	2
	12 mm	3

6600 M/326



066000326

155

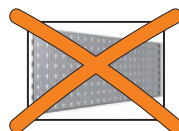

1263/E85



1263/E70



			N°
1260 ●		2,5x50 mm	7
		2,5x75 mm	6
		3x75 mm	7
		3x100 mm	
		3,5x100 mm	
		4x100 mm	6
		4x125 mm	
		5,5x125 mm	
		5,5x150 mm	
		6,5x150 mm	4
1260E ●		10x200 mm	3
		12x250 mm	2
1260N ●		4x30 mm	6
		6,5x30 mm	

			N°
1262 +		PH0x60 mm	7
		PH0x100 mm	
		PH1x80 mm	6
		PH1x120 mm	
		PH2x100 mm	9
		PH2x150 mm	5
		PH3x150 mm	
		PH4x200 mm	4
1262E +		PH2x150 mm	5
		PH3x175 mm	4
1262N +		PH1x30 mm	6
		PH2x30 mm	



6600 M/327



066000327

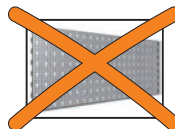

1263/E62



1263/E39



1267TX 		N°
	T5	5
	T6	6
	T7	5
	T8	6
	T9	5
	T10	6
	T15	
	T20	
	T25	5
	T27	4
	T30	
	T40	2
T45		

1268RTX 		N°
	T9	6
	T10	
	T15	
	T20	
	T25	
	T27	4
	T30	3
T40	2	

6600 M/330



066000330

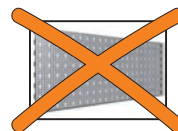

1263/D10 2X



1263/E50



1263/E40



Code	Image	Specifications	N°
1260		2,5x75 mm 3x100 mm 4x125 mm 5,5x150 mm 6,5x150 mm	1
1260N		4x30 mm	1
1262		PH0x60 mm PH1x80 mm PH2x100 mm	1
1262N		PH1x30 mm	1

Code	Image	Specifications	N°
1264		2,5x60 mm 3x75 mm 3x100 mm 4x100 mm 4x125 mm 5x125 mm 5x150 mm 6,5x150 mm	7 6 6 5

Code	Image	Specifications	N°
1269PZ		PZ0 PZ1 PZ2 PZ3 PZ4	7 6 5
1269N/PZ		PZ1 PZ2	6

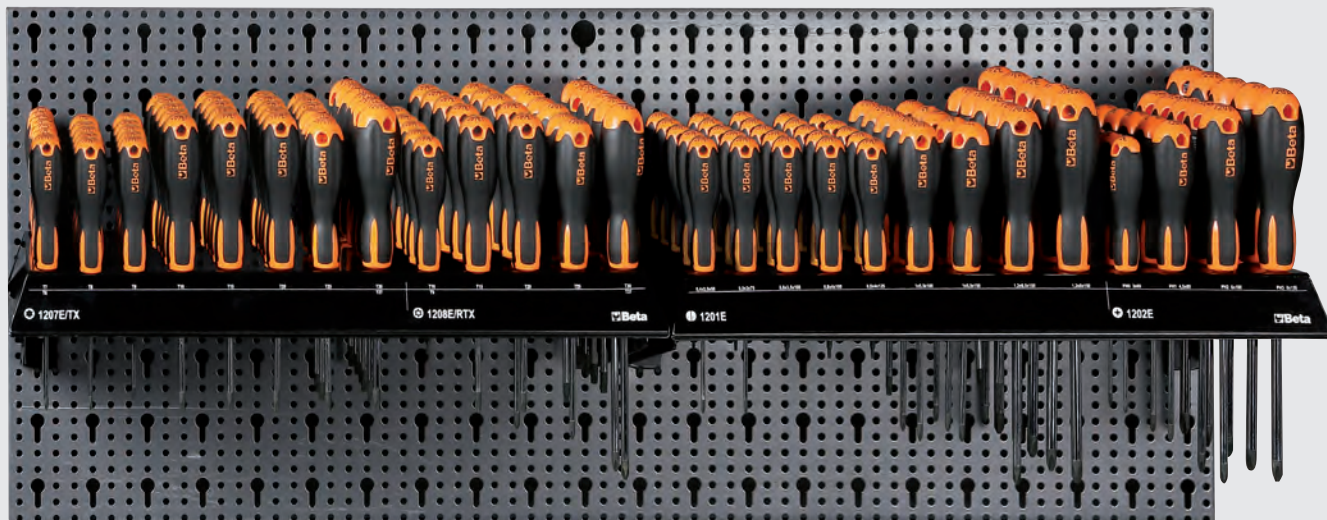
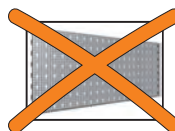

1203E/E1P



1203E/E10P

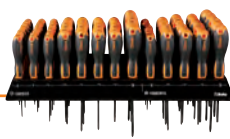

		N°	
1201E ●		2,5x50 mm 7 3x75 mm 3,5x100 mm 4x100 mm 4x125 mm	
		5,5x100 mm 6 5,5x150 mm 6,5x150 mm 8x150 mm 5	
	1202E +		PH0x60 mm 7 PH1x80 mm 6 PH2x100 mm PH3x150 mm 5

		N°	
1207E/TX ⊙		T6 4 T7 3 T8 7 T9 6 T10 T15 T20 T25 T27 3 T30	
	1208E/RTX ⊕		T9-T10 3 T15 6 T20 T25 T27 3 T30

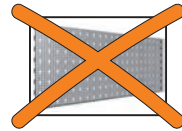

1263/D7

2X

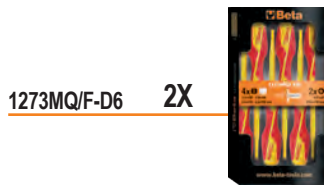

1273MQ/F-D6

2X



1273MQ/D6

2X

		N°
1262 ⊕ ⊖	 PH0x60 mm PH1x80 mm PH2x100 mm	1
1264 ⊖ ⊕	 2,5x60 mm 3x100 mm 4x125 mm 5x125 mm	1

		N°
1274MQ/F ⊖	 3,5x100 mm 4,5x100 mm 5,5x125 mm 6,5x150 mm	1
1272MQ/F ⊕	 PH1x80 mm PH2x100 mm	1

		N°
1274MQ ⊖	 3x100 mm 4x100 mm 5,5x125 mm	1
1272MQ ⊕	 PH0x60 mm PH1x80 mm PH2x100 mm	1



1257LPH/S8

2X

		N°
1257LP ⊖	 0,4x2 mm 0,4x2,5 mm 0,5x3 mm 0,6x3,5 mm 0,8x4 mm	1
1257PH ⊕	 PH00 PH0 PH1	1

		N°
1253 ⊖	 150/250V	5
1253A ⊕	 125/150V	5

		N°
1254 ⊖	 6÷24V	5

6600 M/406



066000406

107

6

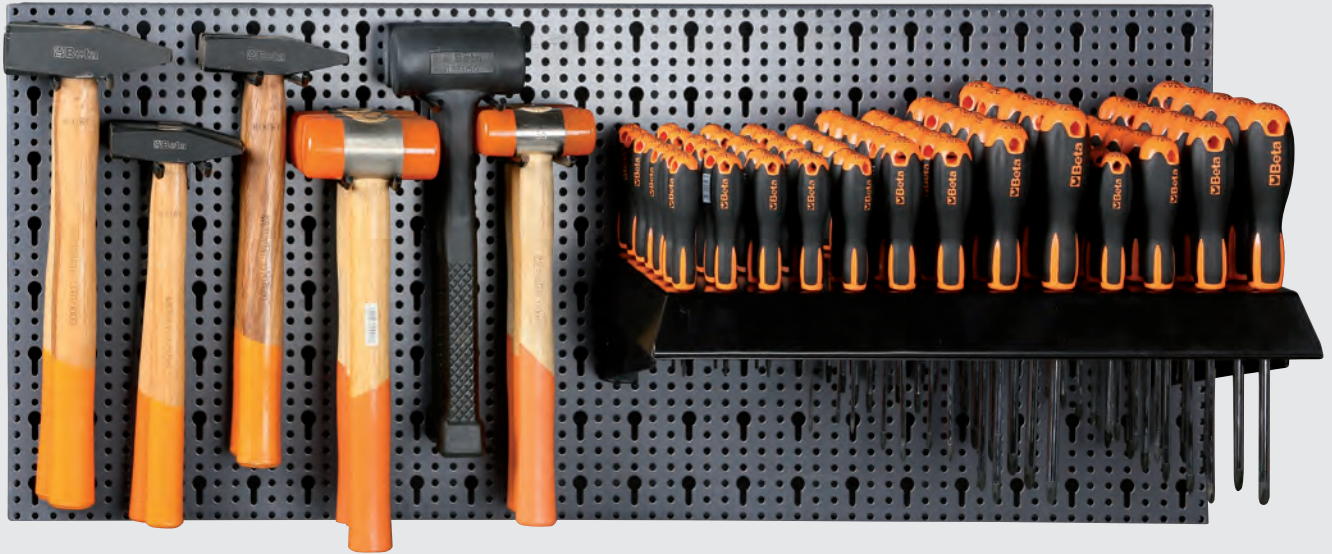
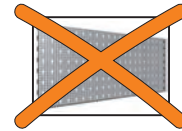

		N°
1370		300 g 5
		500 g 4
		1000 g 4
1390		35 mm 5
		45 mm 4
1391		50 mm 2

1203E/E1P

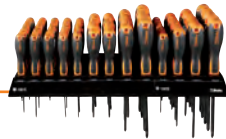

		N°
1201E ●		2,5x50 mm 7
		3x75 mm
		3,5x100 mm
		4x100 mm
		4x125 mm
		5,5x100 mm 6
		5,5x150 mm
1202E +		6,5x150 mm
		8x150 mm 5
		PH0x60 mm 7
		PH1x80 mm 6
	PH2x100 mm	
	PH3x150 mm 5	

6600 M/417



066000417

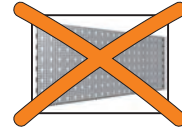

		N°
1370		300 gr 5
		400 gr 5
		500 gr 4
		800 gr 4
		1000 gr 2
		1500 gr 2
1370T		300 gr 5
		500 gr 5
		800 gr 4
		1000 gr 2
		1500 g 2

6600 M/423



066000423

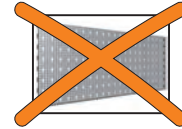



1370F		30-32 mm	4
		36-40-42 mm	3
1370FT		30-32 mm	3
		36-40-42 mm	2

6600 M/424

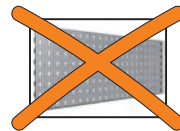

066000424







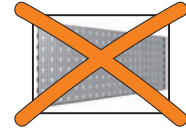

		N°
1370T		300 gr 5
		500 gr 5
		800 gr 4
		1000 gr 2
		1500 gr 2
1377T		340 gr 4
		450 gr 4
		570 gr 4
		680 gr 3
		900 gr 3

6600 M/427



066000427



		N°
1380	 1000 g 1500 g 2000 g	2
1380S	 800 g 1000 g	2
1385	 600 g 800 g 1000 g	2
1392	 30 mm 35 mm 40 mm 50 mm	2

6600 M/430



066000430

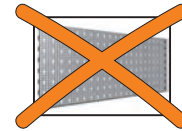

	mm	N°
1390	22 mm	5
	28 mm	
	35 mm	
	45 mm	4
	60 mm	2
1391	35 mm	2
	50 mm	
	55 mm	
	65 mm	

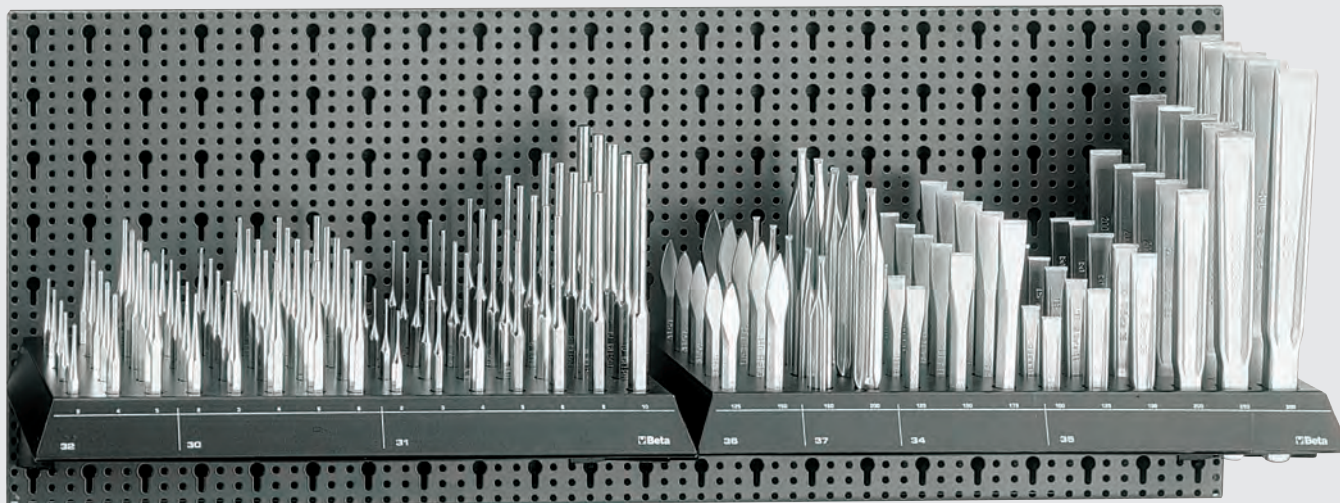
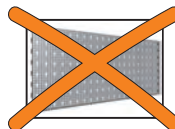









38/DS1



38/DS2



		N°
30		Ø 2-3-4 5-6 mm 5
31		Ø 2-3-4-5 6-8-10 mm 5
32		Ø 3-4-5 mm 5

		N°
34		125 mm 5 150 mm 175 mm
35		100 mm 5 125 mm 150 mm 200 mm 250 mm 300 mm
36		125 mm 5 150 mm
37		150 mm 5 200 mm

6600 M/456



066000456

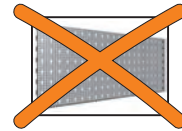

		N°
1044	250 mm	5
1047	240 mm	5
1047BM	250 mm	4
1048	175 mm 250 mm 300 mm	3 5 4
1048V	175 mm 250 mm 300 mm	3 5 4
1048BM	250 mm	3

6600 M/465



066000465

36

20

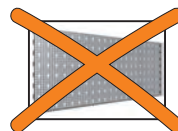

	N°	
332		Ø 3÷16 mm 6
334		Ø 3÷30 mm 3
336		Ø 6÷38 mm 3
338		Ø 6÷67 mm 2
340		Ø 0÷26 mm 2

	N°	
342		Ø 0÷42 mm 2
342A		Ø 0÷50 mm 2
359		1"÷1.1/4" 2
359CH		1.1/2" 2
388A/1		Ø 6-8 10 mm 2

	N°	
388A/2		Ø 1/4" 5/16" 3/8" 2
392C		Ø 25÷65 mm 2
393		270 mm 2
395		15÷32 mm 2
395T		10÷32 mm 2

6600 M/480



066000480

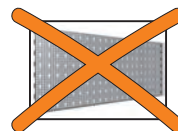

		N°
362		350 2 (Ø 60 mm) 450 (Ø 76 mm)
363		350 2 (Ø 60 mm) 450 (Ø 76 mm)
375		320 2 (Ø 34 mm) 410 (Ø 49 mm)
378		320 2 (Ø 34 mm) 410 (Ø 49 mm)
384		Ø 115 mm 2

6600 M/485



066000485

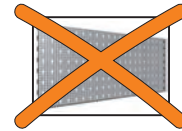

			N°
374		320 mm 410 mm 550 mm	2
376		320 mm 410 mm 550 mm	2

6600 M/510





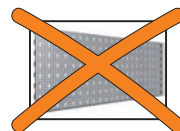



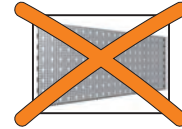

066000510



			N°
1101		300 mm 350 mm 450 mm 600 mm	3
1102		230 mm	4



		200 mm 300 mm 250 mm	N° 2 4
1112		250 mm 350 mm	2
1114		280 mm	2
1120A		250 mm	2

		250 mm	N° 2
1123		250 mm	2
1124		250 mm	2
1125		250 mm	2
1126		250 mm	2

6600 M/534



066000534

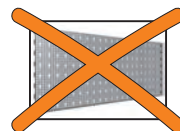

		mm	N°
1128 FX		145 mm	5
1128 BSX		145 mm	10
1130 BMX		190 mm	4
1131CK		203 mm	3

		mm	N°
1132		230 mm	4
1771BM		18 mm	10
1772R		18 mm	5
1772M		18 mm	5

		mm	N°
1771HD		18 mm	5

6600 M/542



066000542

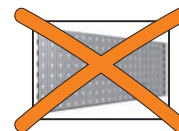

		N°
1719BM A/M	▷ 200 mm	5
1719BM A/P	▮ 200 mm	5
1719BM A/Q	■ 200 mm	5
1719BM A/R	● 200 mm	5

1719BM A/T	▲ 200 mm	5
1719BM RL	▮ 200 mm	5
1719BM RR	● 200 mm	5
1725CR	250 mm	5

1726	440 mm	4
1727	515 mm	4
1727BM	315 mm	5

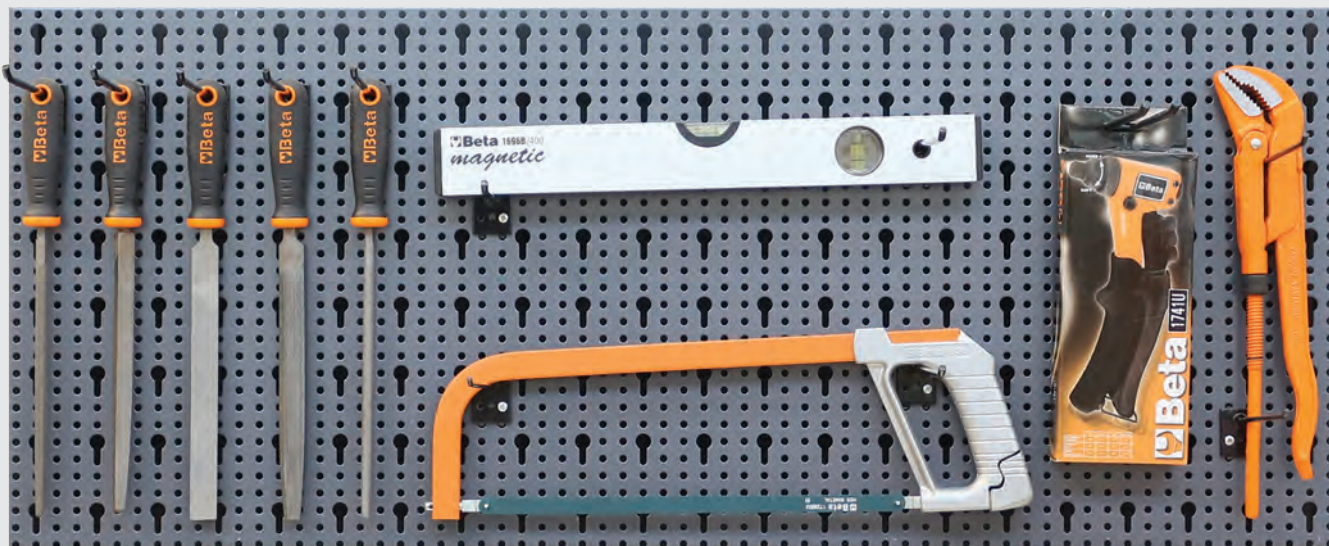
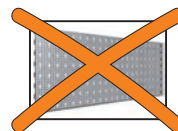

			N°
1719BM A/M		▷ 200 mm	5
1719BM A/P		▮ 200 mm	5
1719BM A/Q		■ 200 mm	5
1719BM A/R		● 200 mm	5
1719BM A/T		▲ 200 mm	5

			N°
1726		440 mm	4
374		320 mm	3
1696B		400 mm	2
1741U			3

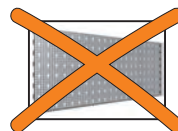

446/C30

		N°
435		/0 5
		M2÷M8 /1 3
		M3÷M10 /1,5
		M3÷M12 /2
		M4÷M14 /3 2
		M5÷M21
436		/1 5
		M3÷M8 /2
		M5÷M12
436L		/1 2
		M3÷M8 /2
		M5÷M12

		N°
430		M3x0,5 1
		M4x0,7
		M5x0,8
		M6x1
		M8x1,25
		M10x1,5
440		M12x1,75 1
		mm
		M3x0,5
		M4x0,7
		M5x0,8
		M6x1
435/1,5		M8x1,25
		M10x1,5
		M12x1,75
		mm
		M3÷M12 1
444/1		Ø25,4 mm 1

6600 M/583



066000583

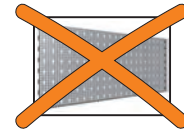

		N°
1650		2
1651DGT		2
1692		5 m 8 m
1694A/L		50 m
1694B/L		50 m
1696B		400 mm 500 mm

6600 M/640



066000640

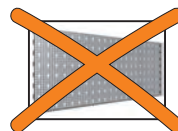

1273MQ/E2



943MQ/BG









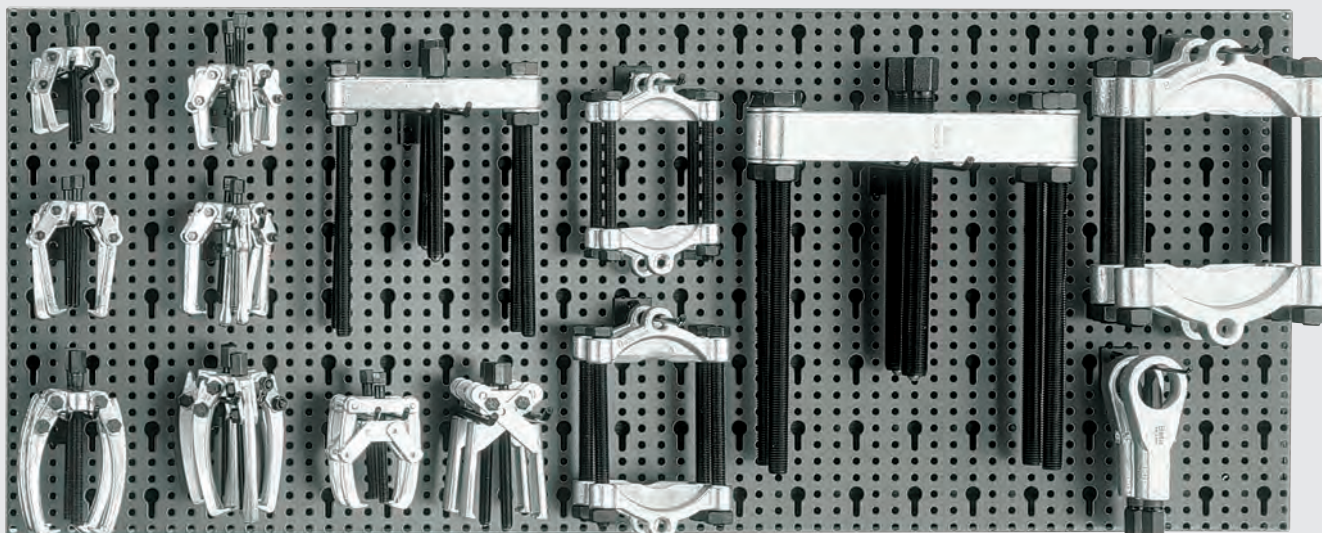
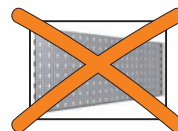

		N°
850MQ △1000 V 	233 mm	3
1082MQ △1000 V 	160 mm	3
1150MQ △1000 V 	180 mm	3
1048MQ △1000 V 	250 mm	2
1166MQ △1000 V 	160 mm	4
1777 MQ/U △1000 V		2

		N°
1272MQ/F △1000 V 	4,5x80 mm 6x100 mm	3
1274MQ/F △1000 V 	3,5x100 mm 4,5x100 mm 5,5x125 mm 6,5x150 mm	3
1275MQ/C △1000 V 	PH1 LPP 4,5x80 mm PH2 LPP 6x100 mm	5
1276MQ/C △1000 V 	PZ1 LPP 4,5x80 mm PZ2 LPP 6x100 mm	5
1279MQ/F △1000 V 	PZ1 4,5x80 mm PZ2 6x100 mm	3 2

		N°
943MQ △1000 V 	5,5 mm 6 mm 7 mm 8 mm 10 mm 13 mm	5



		N°
1506	 10÷50 mm	2
1508	 6÷100 mm /1	2
1515	 0÷60 mm /1 0÷70 mm /2 0÷90 mm /3	2
1516	 0÷60 mm /1 0÷70 mm /2 0÷90 mm /3	2

		N°
1533	 45÷134 mm /2 55÷205 mm /3	2
1534	 0÷70 mm /1 0÷85 mm /2 0÷115 mm /3	2
1709/18	 0÷25 mm M16	2







17

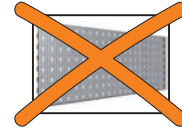

14



		N°
1500N		/0 3 Ø max 65 mm
		/1 2 Ø max 90 mm
		/2 2 Ø max 120 mm
		/3 2 Ø max 170 mm
		/4 1 Ø max 220 mm
1518		/5 1 Ø max 290 mm
		/1 1 24÷100 mm
1521		/1 1 0÷110 mm

6600 M/658





066000658

14

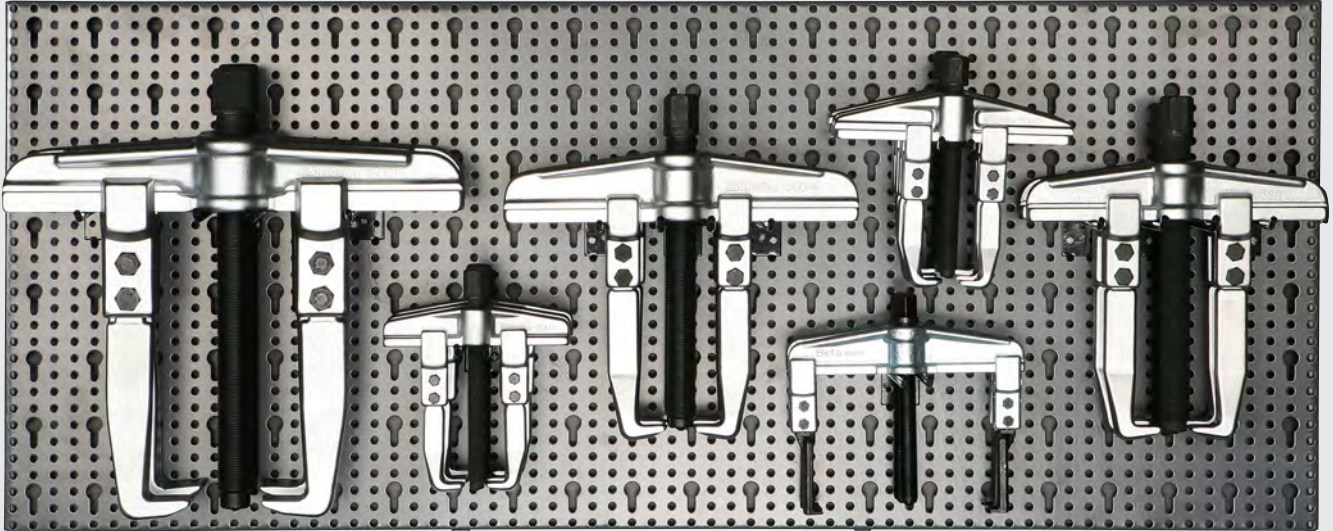
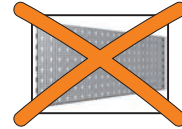
11







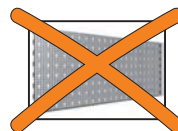

		N°
1500		/1 3 25÷80 mm
		/2 2 25÷130 mm
		/3 2 50÷160 mm
		/4 2 60÷200 mm
		/35 2 80÷250 mm
1501		/1 2 25÷130 mm

6600 M/716



066000716



		N°
720 O 12		10 mm 4
		11-12 mm 2
		13 mm 4
		14-15-16 mm 2
		17 mm 4
		18 mm 2
		19-21-22 mm 4
		23 mm 2
		24 mm 4
		27 mm 3
30-32-36 mm 2		
720/15 12		□1/2x■3/8 2
720/16 12		□1/2x■3/4 2
720/20 12		75 mm 2
720/21 12		125 mm 2

		N°
720/25 12		1
1927 XM 12 CE		10.000 rpm 770 Nm
1927P 12 CE		7.500 rpm 1.750 Nm
1927G 12 CE		8.500 rpm 325 Nm
1928XM 34 CE		4.800 rpm 1.600 Nm

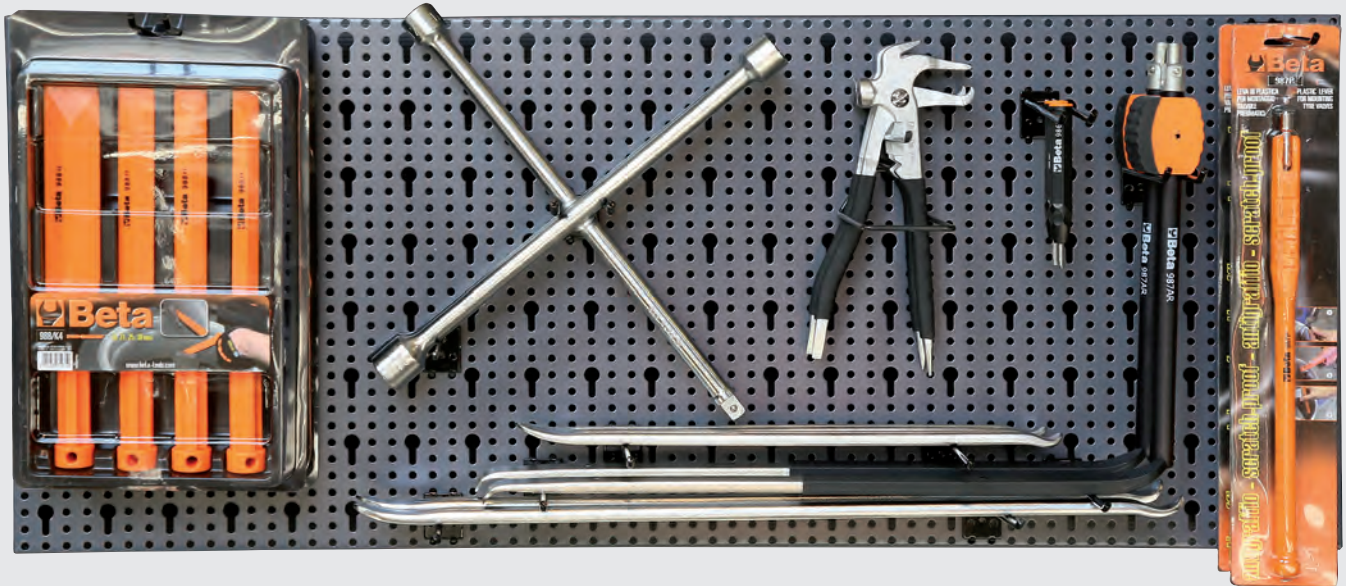
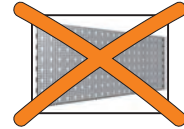

		N°
962	400 mm 600 mm	5 3
962P	490 mm	2
979	17x19x22x ■ 1/2 mm	2

		N°
986PT	120 mm	2
987AR	305 mm	2
987P	335 mm	5

		N°
988/K4	A: 19 mm 21 mm 25 mm 38 mm	2
989	250 mm	2



36

16

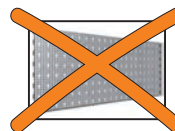

		N°
1482	 Ø 89-170 mm	2
1488	 Ø 60-110 mm	2
1488L	 Ø 60-160 mm	3

		N°
1490	 Ø max 160 mm Ø max 240 mm	1/3
1491	 Ø 65-110 mm	3
1491R		10

		N°
1492/2	 Ø 80-110 mm	3
1493X/1	 Ø 60-80 mm	2
1496/C	 ■ 8x ■ 10 mm	3
1758LG	 L=365 mm	2

6600 M/852



066000852

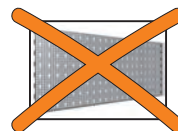

		N°
11001		115x3,2 40
11021		115x3,2 40
11011		115x6,5 20
11011H		230x6,5 20



		N°
11034		115x1,0 100 115x1,6 100
11038		230x2,0 40
11045		115x1,0 100 115x1,6 100

6600 M/856

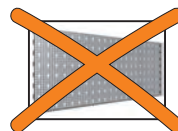

066000856



			N°
11001		125x3,2	40
11021		125x3,2	40
11011H		125x6,5 230x6,5	20 20

			N°
11035		125x1,0 125x1,6	100 100
11038		230x2,0	40
11046		125x1,0 125x1,6	100 100

6600 M/857



066000857

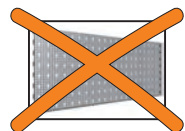

11001		125x3,2	40
		125x3,2	40
11011H		125x6,5	20
		230x6,5	20

11034		115x1,0	100
		115x1,6	100
11035		125x1,0	100
		125x1,6	100
11038		230x2,0	40

6600 M/871



066000871

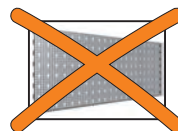

			N°
11200 A 40		Ø 115/40 mm	10
11204 A 40		Ø 115/40 mm	10
11202 A 40		Ø 115/40 mm	10
11212 A 40		Ø 115/40 mm	10

			N°
11216 A 40		Ø 115/40 mm	10
11214 A 40		Ø 115/40 mm	10
11230 A 40		Ø 115/40 mm	10
11234 A 40		Ø 115/40 mm	10

			N°
11240 A 40		Ø 115/40 mm	10
11242 A 40		Ø 115/40 mm	10
11246 A 40		Ø 115/40 mm	10
11248 A 40		Ø 115/40 mm	10

6600 M/878





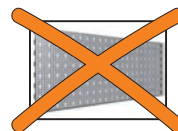



066000878

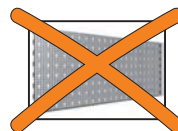







		N°
11204B 40	 Ø 125/40 mm	10
11208B 40	 Ø 125/40 mm	10
11210B 40	 Ø 125/40 mm	10
11204B 60	 Ø 125/60 mm	10
11216B 60	 Ø 125/60 mm	10

		N°
11216 B 40	 Ø 125/40 mm	10
11218B 40	 Ø 125/40 mm	10
11220B 40	 Ø 125/40 mm	10
11240B 40	 Ø 125/40 mm	10
11248B 40	 Ø 125/40 mm	10



		N°
11263 15-60	 Ø 30x15 mm	40
11263 15-80	 Ø 30x15 mm	40
11264 20-40	 Ø 40x20 mm	40
11264 20-60	 Ø 40x20 mm	40
11265 20-60	 Ø 50x20 mm	40



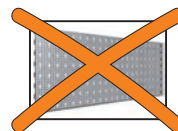

		N°
11265 20-80	 Ø 50x20 mm	40
11265 30-60	 Ø 50x30 mm	40
11265 30-80	 Ø 50x30 mm	40
11266 30-40	 Ø 60/30 mm	30
11266 30-60	 Ø 60/30 mm	30
11266 30-80	 Ø 60/30 mm	30



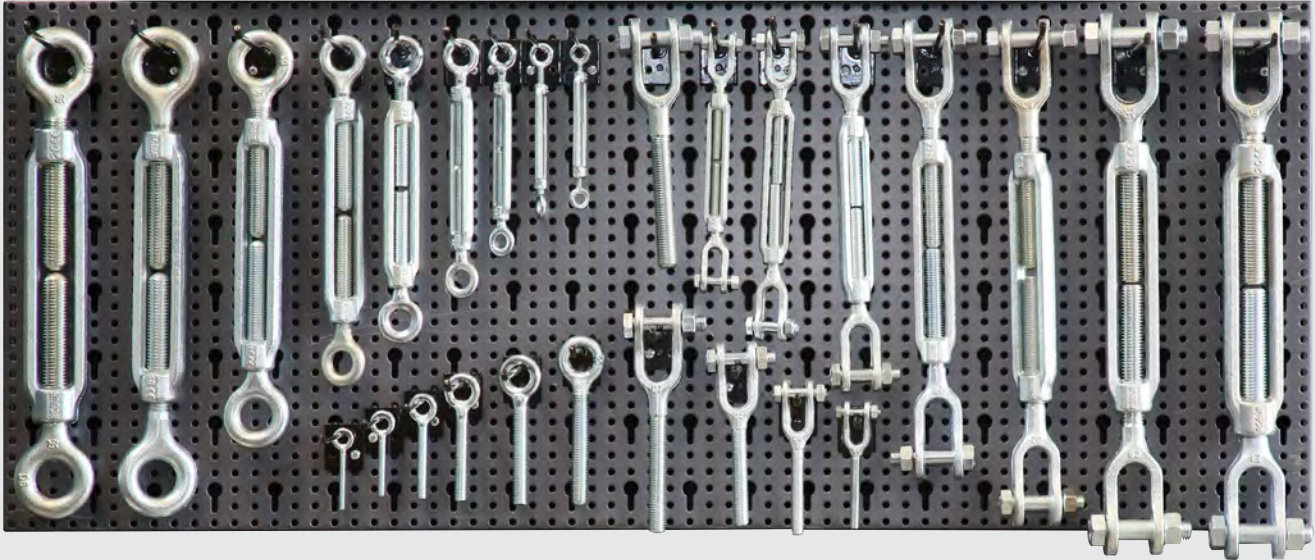
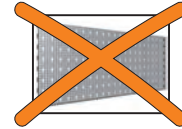



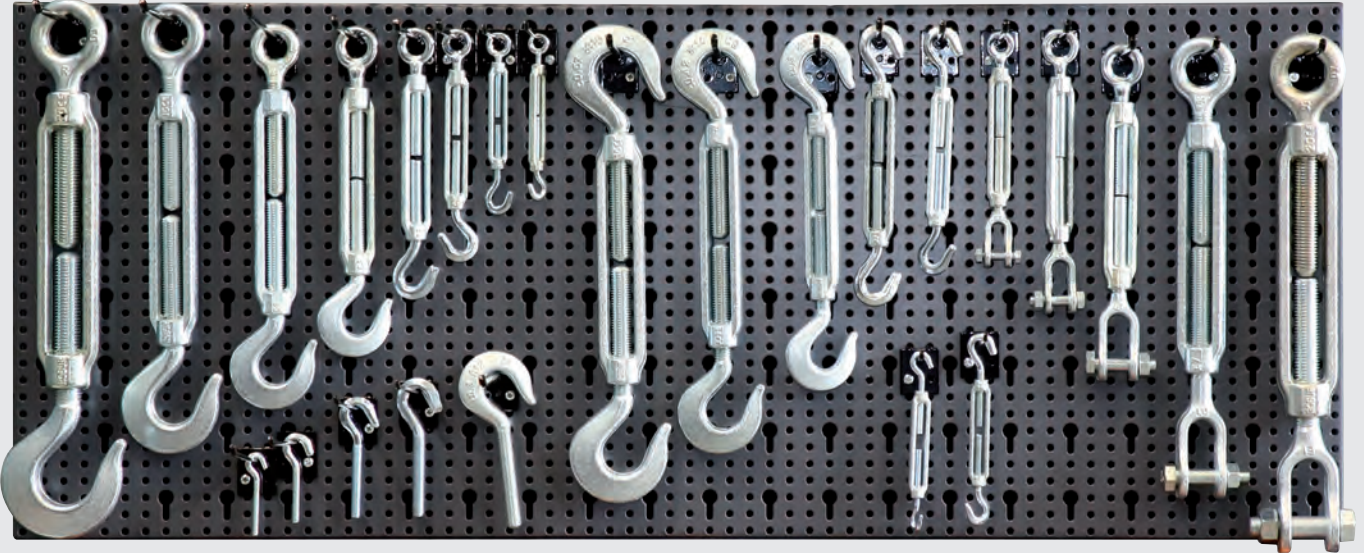
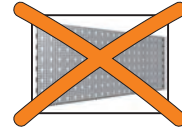

Code	Image	Size	N°
8002ZD		M5	20
		M6	
		M8	
		M10	10
8003ZD		M5	10
		M6	
		M8	
		M10	5
8005Z cē		M5	30
		M6	
		M8	20
		M10	15
		M12	
		M14	6
8006Z cē		M5	30
		M6	
		M8	20
		M10	15
		M12	4
		M14	2

Code	Image	Size	N°
8007Z cē		M5	6
		M6	
		M8	4
		M10	
		M12	
8009FD		M8	2
		M10	
		M12	
8009Z cē		M8	4
		M10	
		M12	
		M14	2
		M16	









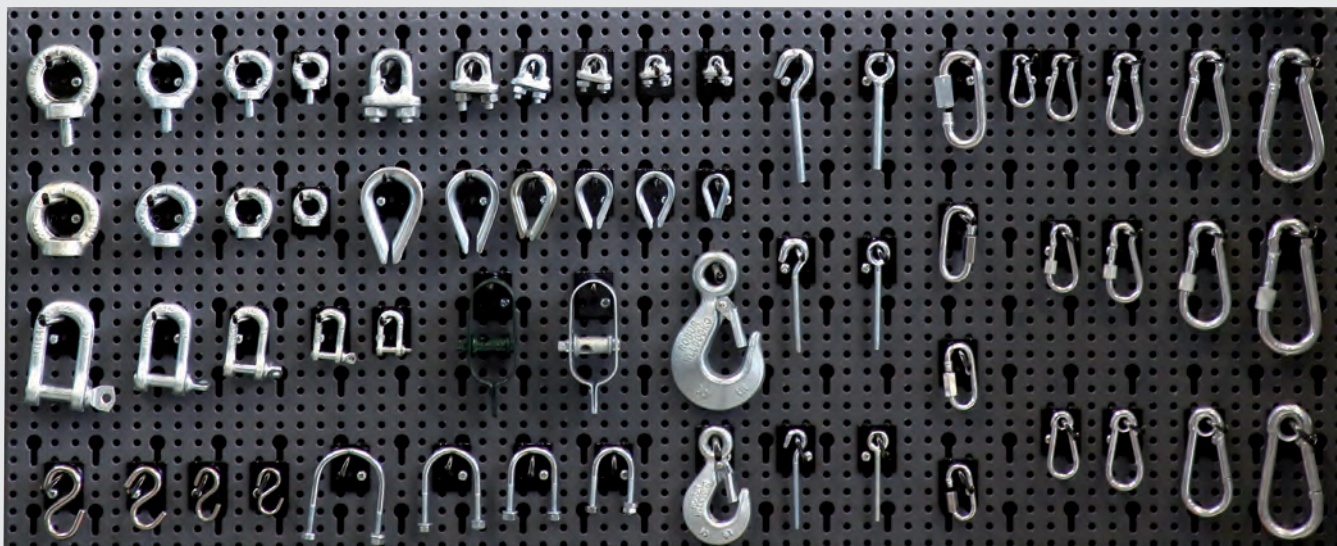
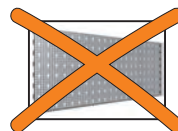





		N°
8002ZD		M5 20
		M6
		M8
		M10
		M12 10
		M14 5
8005Z CE		M5 30
		M6
		M8 20
		M10 15
		M12
		M14 10
		M16 6
		M18 2
M20 4		
8009Z CE		M8 6
		M10 4
		M12 4
		M14 2
		M16
		M18
M20		
8009FD		M8 2
		M10
		M12
		M14
		M16









		N°
8003ZD		M5 15
		M6 12
		M8 10
		M10 6
		M12
8006Z CE		M5 30
		M6
		M8 20
		M10 15
		M12 10
		M14 8
		M16 4
		M20
8007Z CE		M5 10
		M6
		M8 8
		M10 6
		M12 4
		M14 2
		M16
8010Z CE		M8 6
		M10 4
		M12
		M16 2
		M20









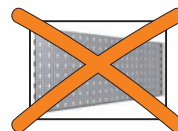



		N°
8016 cc		3 mm 100
		5 mm 50
		6 mm
		8 mm 30
		10 mm
8020A		4 mm 150
		5 mm 100
		6 mm
		8 mm 50
		10 mm 30
8025 cc		5 mm 25
		6 mm
		8 mm
		10 mm 15
		12 mm 12
8040EZ cc		M6 30
		M8 20
		M10
		M12 10
8042EZ		M6 30
		M8 20
		M10
		M12 10

		N°
8051S cc		250 kg 15
		500 kg 10
8074		4x40 mm 50
		5x50 mm
		6x60 mm 40
		8x80 mm 30
		10x100 mm 20
8074A		5x50 mm 30
		6x60 mm
		8x80 mm 20
		10x100 mm 10
8074G		5x50 mm 30
		6x60 mm
		8x80 mm 20
		10x100 mm 10
8080		4x40 50
		5x49
		6x57 40
		8x74 30
8083		3 mm 40
		4 mm 30
		5 mm 20
		6 mm 15

		N°
8302Z		M5 30
		M6 20
		M8
8303Z		M5 30
		M6 20
		M8
8381SL		22 mm 20
		27 mm 15
		34 mm 10
		43 mm
8515V		24,5 mm 10
8515Z		24,5 mm 10



		N°
8016 cē		3 mm 50
		5 mm 25
		6 mm
		8 mm 15
		10 mm
8020A		2-3 mm 150
		4 mm
		5 mm 100
		6 mm
		8 mm 50
		10 mm 30
		12 mm 10
8025 cē		5 mm 10
		6 mm
		8 mm
		10 mm 5
		12 mm
		14 mm 10
		16 mm 5
8026A cē		20 mm
		12 mm 10
		14 mm
		16 mm
8029R cē		500 kg 5
		750 kg
		1000 kg 10
		2000 kg 8
		3250 kg 5
		4750 kg 2

		N°
8031R cē		2000 kg 3
		3250 kg
8040EZ cē		M6 20
		M8 10
		M10
		M12
		M16 5
8041 cē		M8 10
		M10 6
		M12 4
		M16 2
8042EZ cē		M6 20
		M8 10
		M10
		M12
		M16 5

		N°
8043 cē		M8 10
		M10 6
		M12 4
		M16 2
8051S cē		250 kg 10
		500 kg 5

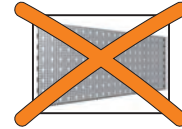

		N°
8052 c€		800 kg 4 1120 kg 2000 kg
8057R c€		2000 kg 2
8058R c€		1120 kg 4 2000 kg 3150 kg 2
8060R c€		1120 kg 4 2000 kg 3150 kg 2

		N°
8061R c€		1120 kg 2 2000 kg 3150 kg
8063 c€		1120 kg 2 2000 kg
8085R c€		1500 kg 2 2000 kg 3150 kg
8090R c€		1120 kg 4 1500 kg 2000 kg 3150 kg 2

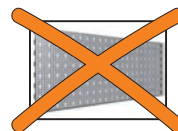

		N°
8205		M4 5
		M5 10
		M6 5
		M8 5
		M10 1
8206		M5 5
		M6 5
		M8 5
8209		M5 5
		M6 5
		M8 5
8216 cē		3 mm 15
		4 mm 10
		5 mm 10
		6 mm 5
8220		3 mm 15
		4 mm 10
		5 mm 10
		6 mm 5
8225		8 mm 5
		4 mm 10
		5 mm 5
		6 mm 5
		8 mm 5
		10 mm 3
12 mm 3		

		N°
8240		M6 5
		M8 5
		M10 5
		M12 5
8242		M6 5
		M8 5
		M10 5
		M12 5
8249		M5 5
		M6 5
		M8 5
		M10 5
8250		50 mm 5
		70 mm 5
8264		12 mm 5
		12 mm 5

		N°
8274		4,5x40 mm 10
		5x50 mm 5
		6x60 mm 5
		7x70 mm 5
		8x80 mm 5
		10x100 mm 1
8274G		6x60 mm 3
		10x100 mm 3
		10x100 mm 3
8276G		10x100 mm 3
		10x100 mm 3
8280		5x49 mm 5
		6x57 mm 5
		7x66 mm 5
		8x74 mm 1
8381SX		22 mm 10
		27 mm 10
		34 mm 10
		49 mm 5
		61 mm 5

8600 R/511



086000511

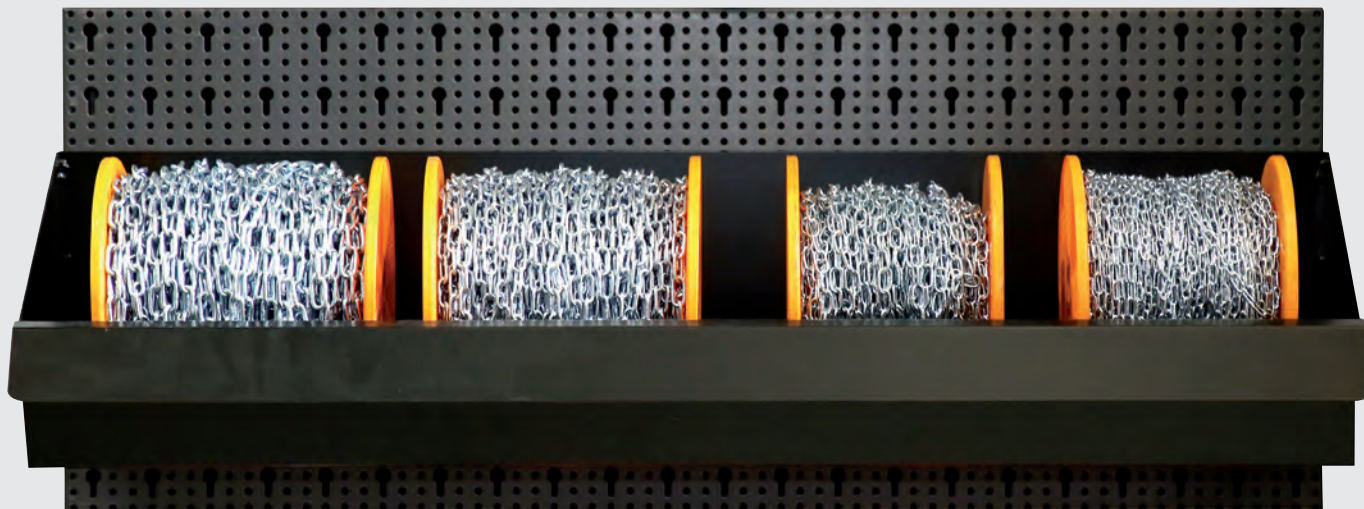
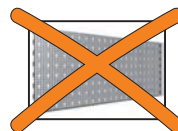

8120





	N°
Ø 2,2 mm x 75 m	2
Ø 2,7 mm x 75 m	2
Ø 3,4 mm x 60 m	1
Ø 4,4 mm x 40 m	1
Ø 4,8 mm x 30 m	2
Ø 5,5 mm x 25 m	1
Ø 6,5 mm x 25 m	2

8600 R/601

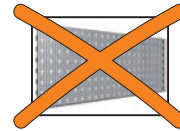

086000601







		N°
8180 €		15
8181 €		15
8182 €		20

8600 R/611

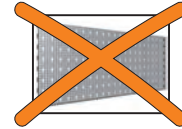

086000611













			N°
8150 c€		1 m - 1000 kg	10
		2 m - 1000 kg	8
		3 m - 1000 kg	6
8153 c€		2 m - 2000 kg	8
		3 m - 2000 kg	6
		4 m - 2000 kg	4
8156 c€		3 m - 3000 kg	6
		4 m - 3000 kg	4



-  **Espositore non incluso**
-  **Display not included**
-  **Présentoir non fourni**
-  **Expositores no incluidos**
-  **Ständer nicht mitgeliefert**
-  **Exclusief de display**
-  **Regał nie wchodzi
w skład zestawu**
-  **Állvány nélkül szállítva**
-  **Expositor não incluído**
-  **Δεν περιλαμβάνεται
εκθετήριο**



- PROPOSTE ESPOSITIVE: ESPOSITORI COMPLETI** 
- DISPLAY SUGGESTIONS: COMPLETE DISPLAYS** 
- PROPOSITIONS D'EXPOSITION : PRÉSENTOIRS COMPLETS** 
- PROPUESTAS EXPOSITIVAS: EXPOSITORES COMPLETOS** 
- AUSSTELLUNGSANGEBOTE: KOMPLETTE STÄNDER** 
- DISPLAY SUGGESTIES: COMPLETE DISPLAYS** 
- PROPOZYCJE EKSPozyCJI: KOMPLETNE ZESTAWY** 
- ÁLLVÁNY AJÁNLATOK: KOMPLETT ÁLLVÁNYOK** 
- SUGESTÃO DE EXPOSITORES: EXPOSITORES COMPLETOS** 
- ΠΡΟΤΑΣΕΙΣ ΠΡΟΒΟΛΗΣ: ΠΛΗΡΗ ΕΚΘΕΤΗΡΙΑ** 

8600 E/R1



1946

187

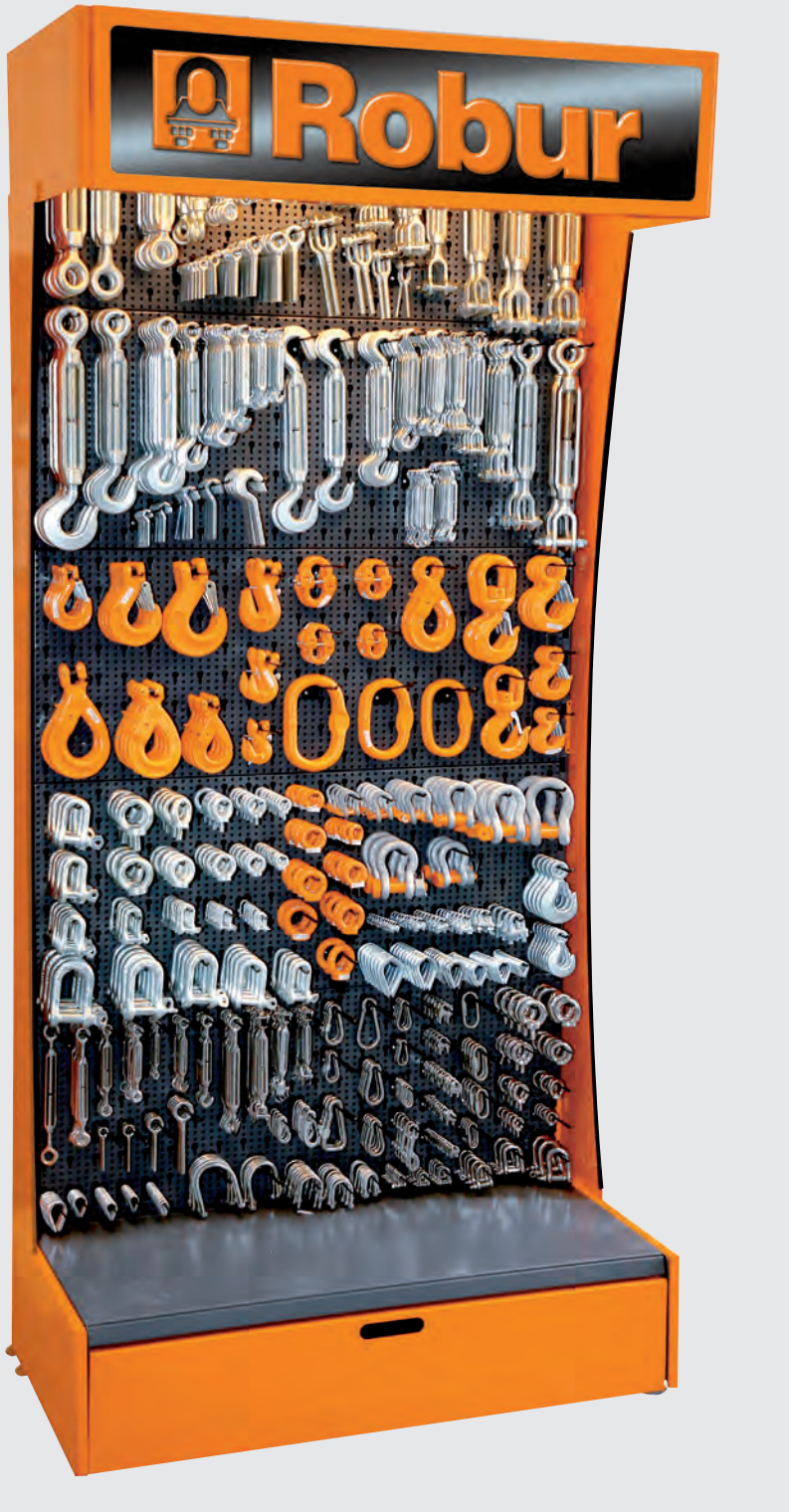

8600 R/12	
8600 R/13	
8600 R/225	
8600 R/114	
8600 R/412	







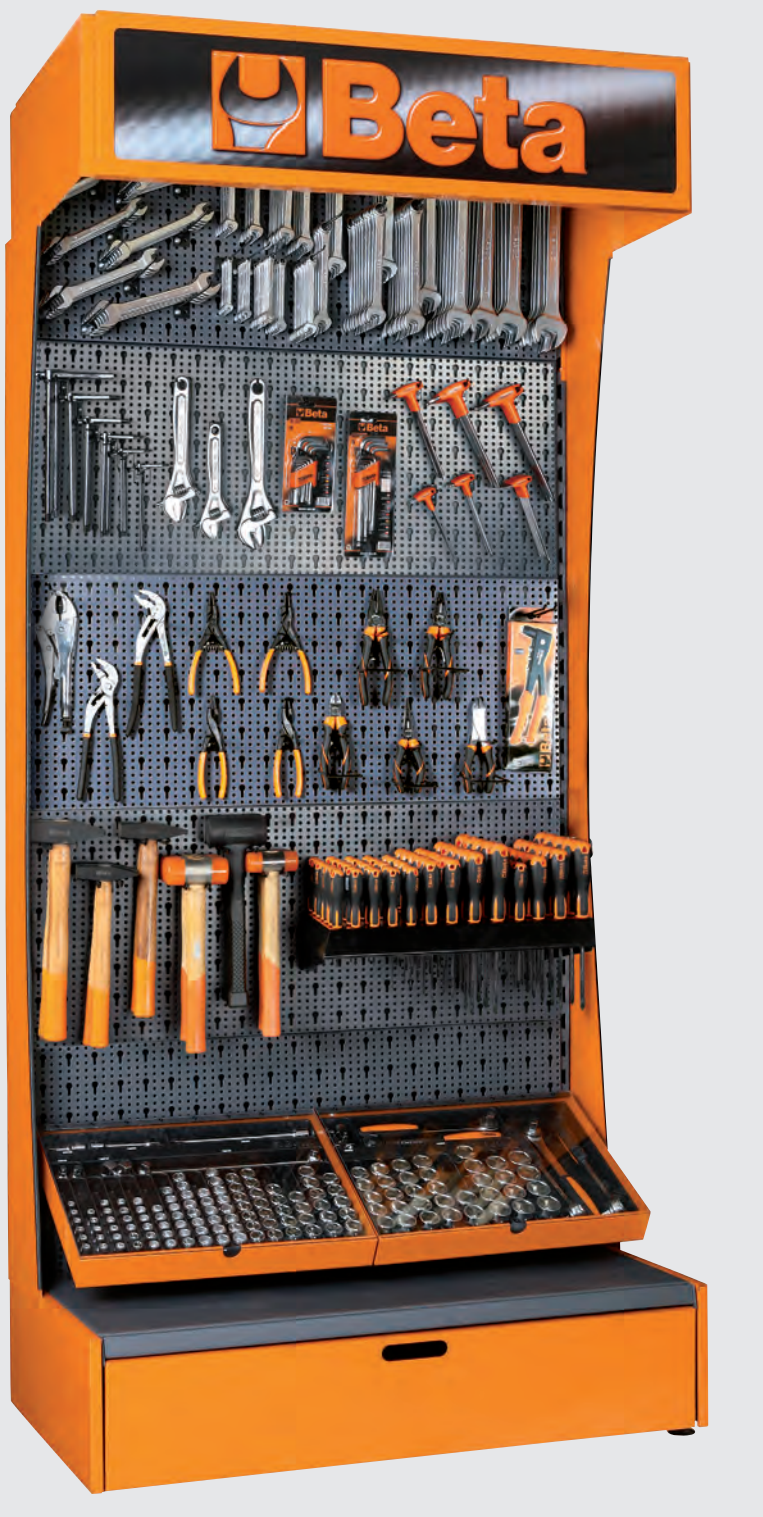

8600 E/R2









		N°
42NEW		6x6-7x7 mm 5
		8x8 mm 10
		9x9 mm 5
		10x10 mm 10
		11x11 mm 5
		12x12 mm
		13x13 mm 10
		14x14-15x15
		16x16 mm
		17x17 mm 10
		18x18 mm 5
		19x19 mm 10
		22x22 mm 5
24x24 mm 8		
27x27 mm 5		
30x30 mm 5		
32x32 mm		
55		6x7-8x9 mm 5
		10x11-12x13 mm 10
		14x15-16x17-18x19-20x22 mm 5
96T ○		2-2,5 mm 5
		3-4-5 mm 10
		6 mm 5
96SC9 ○		1,5-2-2,5-3-4-5-6-8-10 mm 5
96BPC SC9 ○		1,5-2-2,5-3-4-5-6-8-10 mm 10
111		200-250 mm 4
		300 mm 2
951 ○		2,5-3-4-5-6-8 mm 5
1032 ○		180 mm 5
1034 ○		170 mm 5
1036 ●		175 mm 5



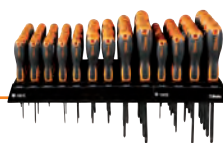







		N°
1038 ●	 175 mm	5
1047	 240 mm	4
1048	 250 mm	5
1052	 240 mm	4
1082BM	 160 mm	5
1084BM	 160 mm	3
1150BM	 180-200 mm	5
1166BM	 160 mm	5

		N°
1370	 300-500 g 1000 g	5 4
1390	 35 mm 45 mm	5 4
1391	 50 mm	2
1741B		4

1203E/E1P



		N°
1201E ●	 2,5x50 mm 3x75 mm 3,5x100 mm 4x100 mm 4x125 mm	7
	5,5x100 mm 5,5x150 mm 6,5x150 mm 8x150 mm	6 5
1202E +	 PH0x60 mm PH1x80 mm PH2x100 mm PH3x150 mm	7 6 5

		N°
920A 12" ○	 8 mm 9 mm 10 mm 11 mm 12 mm 13 mm 14-15 mm 16 mm 17 mm 18-19 mm 20-21 mm 22 mm 23-24-25-26 27-28-29 mm 30-32 mm	6 5 9 5 6 9 8 6 8 7 5 6 5 5 4
920/15 12" ○	 □1/2"x□3/8"	2
920/16 12" ○	 □1/2"x□3/4"	2
920/20 12" ○	 75 mm	2
920/21 12" ○	 125 mm	2
920/22 12" ○	 255 mm	2
920/25 12" ○		2
920/42 12" ○		2
920/50 12" ○		2
920/55 12" ○		4











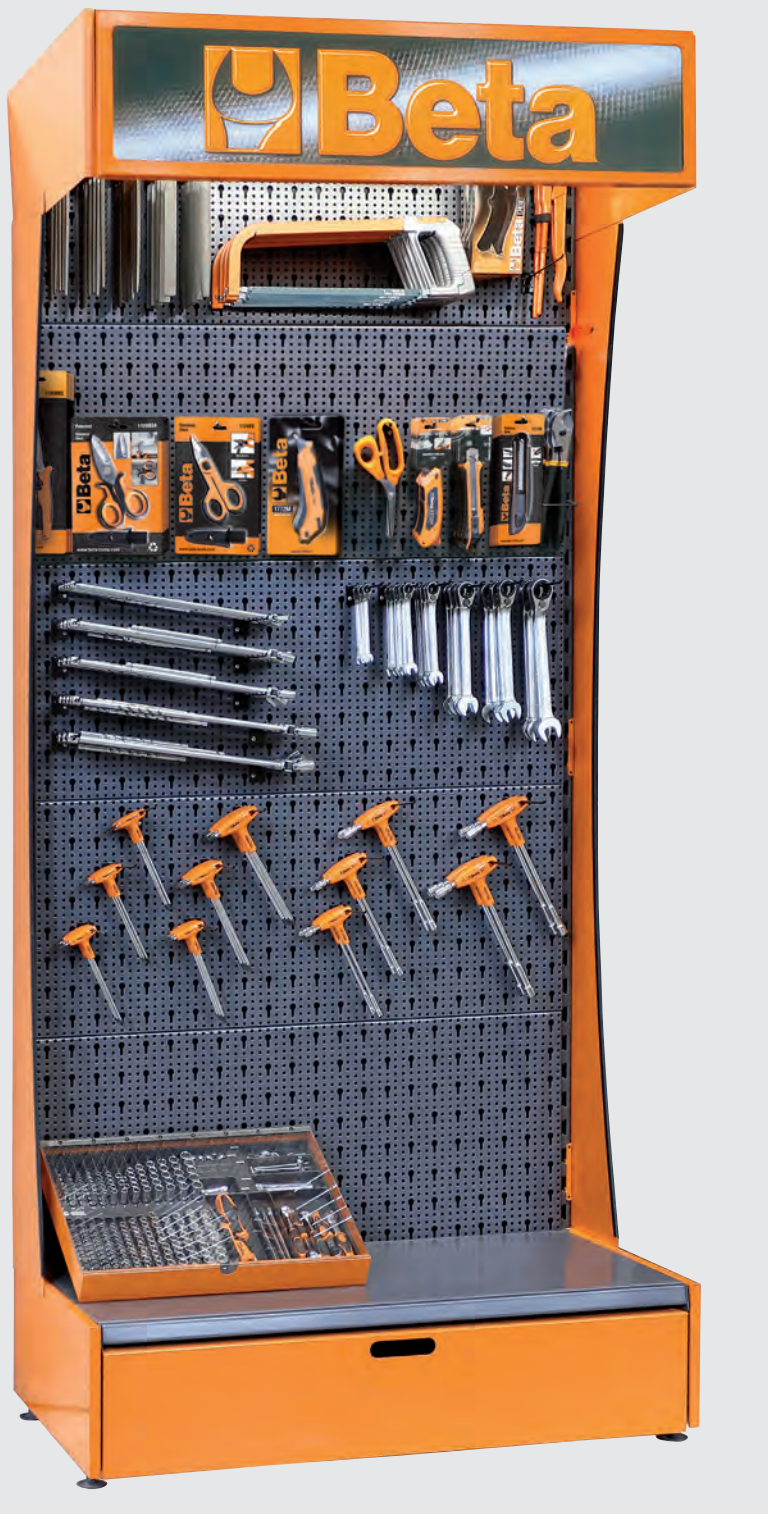

377





46

























		N°
97TTX ⊙		T 10 3 T 15 3 T 20 3 T 25 3 T 30 3 T 40 3
142		8 mm 3 10-13 mm 5 17 mm 4 19 mm 3 22 mm 5
374		320 mm 3
941 ⊙ ⊙		7x7 mm 2 8x8 mm 2 10x10 mm 2 12x12 mm 2 13x13 mm 2
952 ⊙		8-10 5 12-13 mm 3 17 mm 3
1128 FX		155 mm 5
1128 BSX		155 mm 10
1130 BMX		145 mm 4
1331CK		203 mm 3
1132		230 mm 4

		N°
1696		400 mm 2
1719 BMA/M		200 mm 5
1719 BMA/P		200 mm 5
1719A/Q		200 mm 5
1719 BMA/R		200 mm 5
1719 BMA/T		200 mm 5
1771HD		190 mm 5

		N°
1741U		3
1771BM		18 mm 10
1772R		18 mm 5
1772M		18 mm 5
1726		440 mm 4



		N°
900  		4-4,5-5 10 5,5-6-7-8 9-10 mm 11-12-13 mm 8 14 mm 7
900L 		4-4,5-5 5 5,5-6-7-8 9-10-11 12-13-14 mm
900/16 		□1/4" x ■3/8" 5
900/20 		50 mm 3
900/20L 		100 mm 3
900/21 		150 mm 3
900/25 		3
900 BG/30 		176 mm 2
900/42 		3
900/55  		5



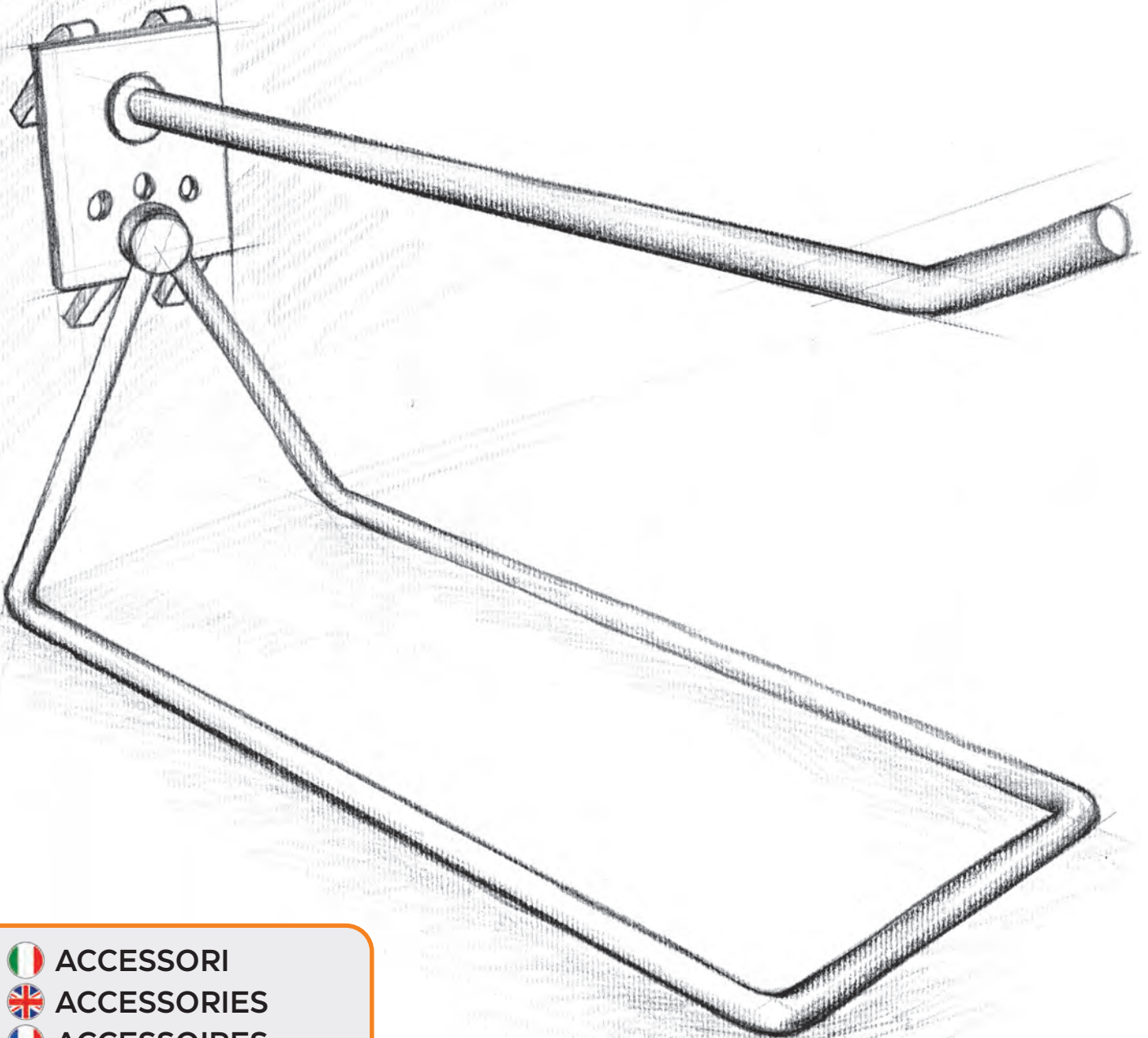

-  ACCESSORI
-  ACCESSORIES
-  ACCESSOIRES
-  ACCESORIOS
-  ZUBEHÖR
-  ACCESSOIRES
-  AKCESORIA
-  TARTOZÉKOK
-  ACESSÓRIOS
-  ΕΞΑΡΤΗΜΑΤΑ



6888 S...

-  Ganci singoli
-  Single hooks
-  Crochets simples
-  Ganchos individuales
-  Einzelhaken
-  Enkele haken
-  Haki pojedyncze
-  Kampó
-  Ganchos simples
-  Μόνο γάντζοι

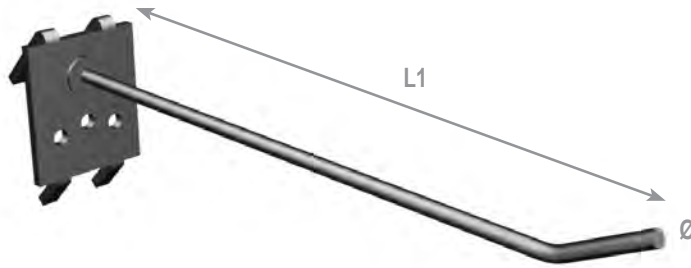



	L1 mm	L2 mm		
S1	150	3,4	10	068880011

	L1 mm	L2 mm		
S2	150	5,2	10	068880012

6888 D...

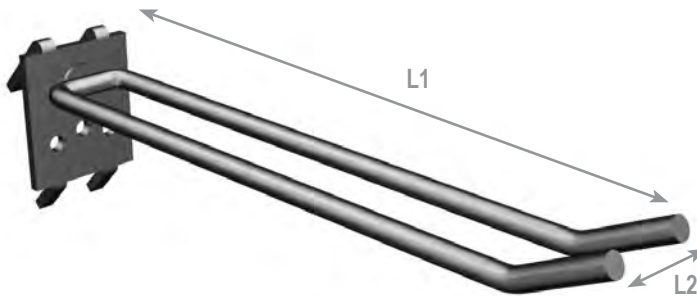
-  Ganci doppi
-  Double hooks
-  Crochets doubles
-  Ganchos dobles
-  Doppelhaken
-  Dubbele haken
-  Haki podwójne
-  Duplakampó
-  Ganchos duplos
-  Διπλοί γάντζοι



	L1 mm	L2 mm		
D1	150	15	5	068880021
D4	150	32	5	068880024

	L1 mm	L2 mm		
D2	150	22	5	068880022
D5	150	44	5	068880025

6888 T...

-  Ganci tripli
-  Triple hooks
-  Crochets triples
-  Ganchos triples
-  Dreifachhaken
-  Drie haken
-  Haki potrójne
-  Hármás kampó
-  Ganchos triplos
-  Τριπλοί γάντζοι

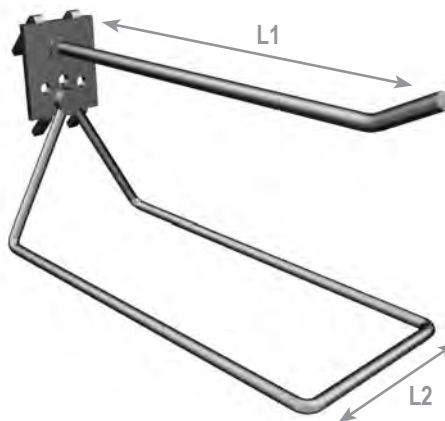

	L1 mm	L2 mm		
T1	150	57	5	068880031

	L1 mm	L2 mm		
T2	150	63	5	068880032

6888 B

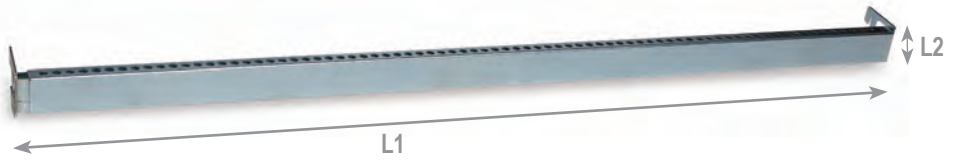

- Barre forate inclinabili per abrasivi
- Steel bar (40x20 mm) complete with fixing plate
- Barre percée basculant pour abrasives
- Barra de acero de 40x20 mm con placa de fijación
- Stahlstange 40x20 mm mit Befestigungsplatte
- Stalen beugel (40x20 mm) compleet met bevestigingsplaat
- Belka stalowa (40x20 mm) z płytka mocującą
- Acél rúd (40x20 mm) rögzítő lemezzel
- Barra em aço (40x20 mm) com placa de fixação
- Χαλύβδινη ράβδος (40x20 mm) πλήρης με πλάκα στερέωσης

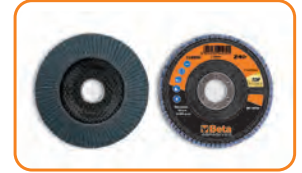

L1 mm	L2 mm		
1000	40	1	068880100

6888 GA

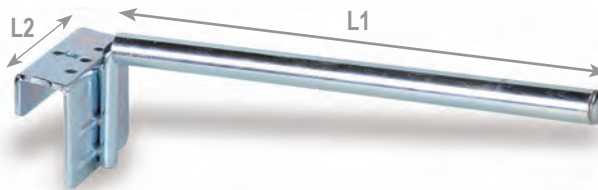

- Gancio per abrasivi
- Disc display hook
- Crochet pour abrasives
- Gancho para exposición discos
- Haken für Scheibenausstellung
- Ophanghaak voor schijven
- Elementy mocujące do regału do ekspozycji tarcz
- Korong bemutató
- Gancho para expositor de discos
- Disc display hook



L1 mm	L2 mm		
200	50	3	068880120

6888 S...

- Gancio
- Hooks
- Crochets
- Ganchos
- Dreifachhaken
- Drie haken
- Haki
- Hármás
- Ganchos triplos
- Hook



S - 1/4



S - 3/8



L1 mm	L2 mm	L3 mm		
65	50	50	1	068880605
65	50	50	1	068880610



6800 MB

068000200

- Espositore polivalente bussole vuoto - 1 mt
- Multi-purpose empty wall-mounted display - 1 meter

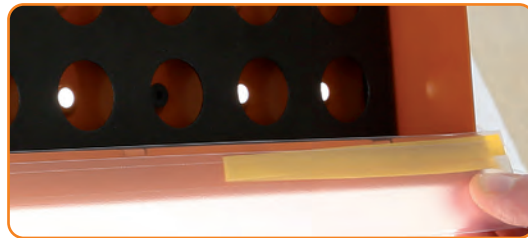
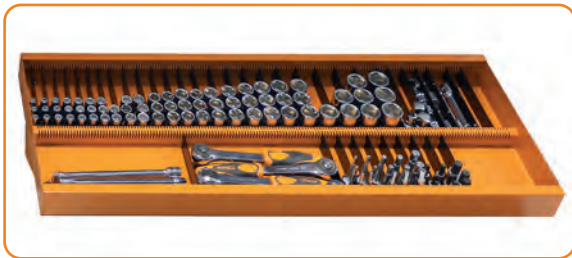
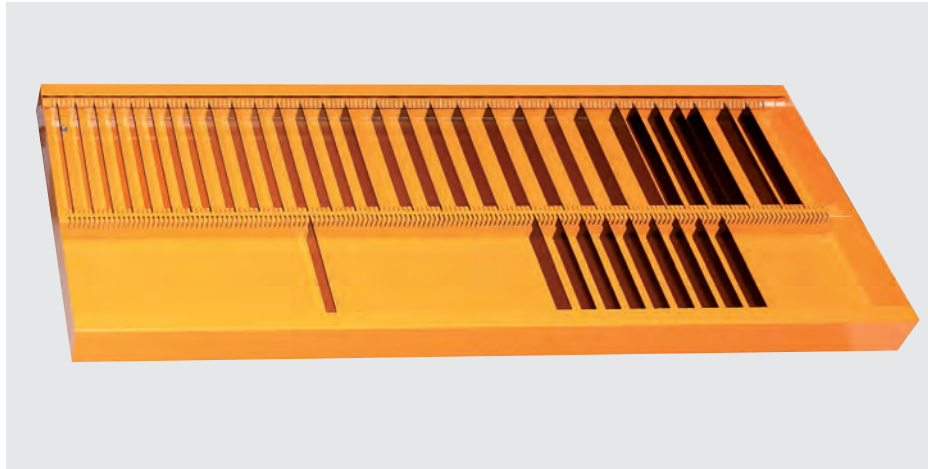

Portaprezzi
Price tag

6800 BIM

068000201

- Espositore bussole maschio esagonale vuoto - 0,5 mt
- Wall mounted display for Amale-end square drive socket wrenches 0,5 meter

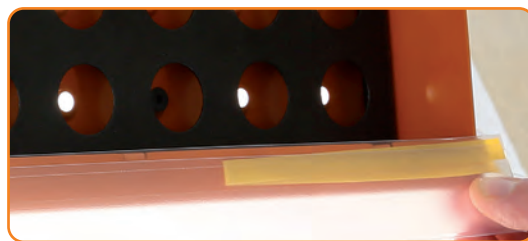











Portaprezzi
Price tag



C88VE

088000120

-  **Vasca espositiva per pareti C88 R/1,**
adatta ad alloggiare bobine di catena art. 8120
-  **Display tray for display walls C88,**
suitable for housing coils of chains item 8120
-  **Plateau d'exposition pour présentoir mural C88,**
apte au rangement de rouleaux de chaîne art. 8120
-  **Bandeja expositiva para paredes C88,**
adecuada para alojar cadenas en bobina art. 8120
-  **Schale für Ausstellungswand Art. C88,**
zur Aufnahme von Kettenspulen Art. 8120
-  **Rek voor verkoopstandaard C88,**
geschikt voor het ophangen van rollen ketting artikel 8120
-  **Pojemnik do ekspozycji łańcuchów na rolkach do regału model C88,**
odpowiedni do umieszczenia łańcuchów na rolkach model 8120
-  **Kiállító tálcá C88 falhoz,**
a 8120 cikkszámú lánctekercsek elhelyezésére alkalmas
-  **Tabuleiro para expositor de parede C88,**
adequado para bobinas das correntes artigo 8120
-  **Δίσκος εκθετήριο για C88,**
κατάλληλος για ρολά αλυσίδας 8120

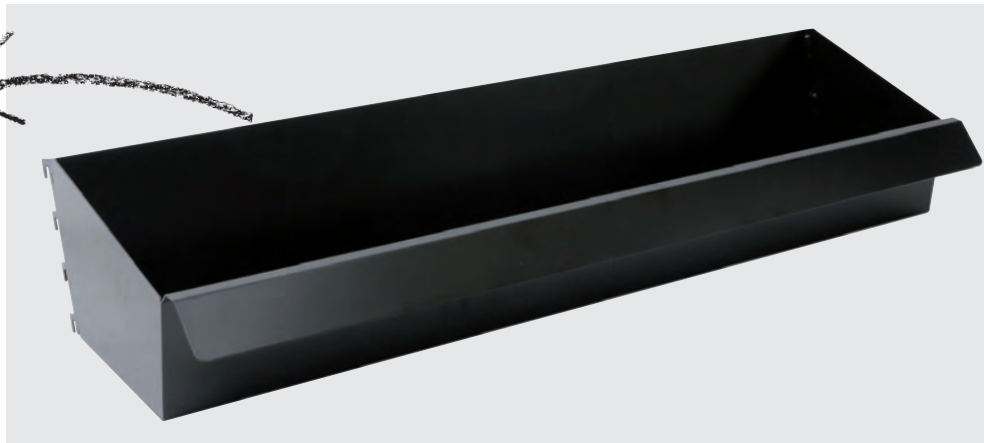

6888CG

068880002

-  **Coppia spalle per espositori da parete**
-  **Pair of side supports for wall-mounted displays**

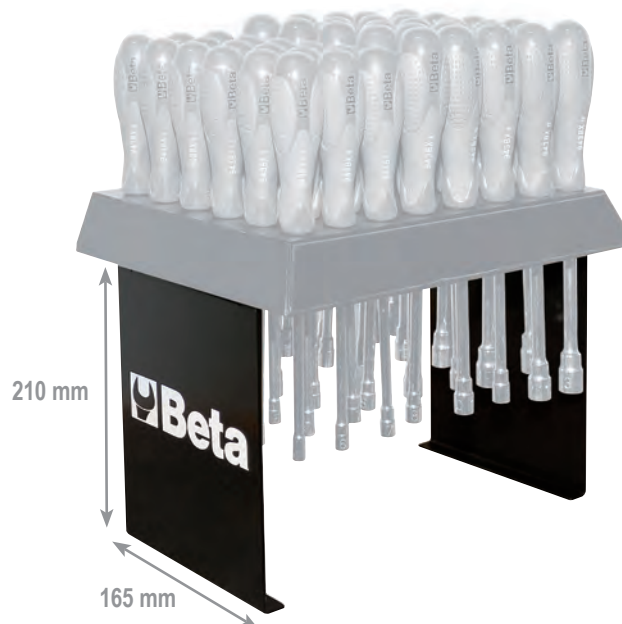

6888 VE/...

-  **Vetrinetta espositore parete**, H 180 cm,
vetro temprato, serratura
-  **Wall-mounted display showcase**, H 180 cm,
tempered glass, lock
-  **Vitrine présentoir murale**, H 180 cm,
verre trempé, serrure
-  **Vitrina expositor de pared**, H 180 cm,
cristal templado, cerradura
-  **Wandständervitrine**, H 180 cm,
gehärtetes Glas, Verschluss
-  **Muur display met vitrine**, H 180 cm,
gehard glas, slot
-  **Gablota wystawiennicza**, H 180 cm,
szkło hartowane, zamek
-  **Fali bemutató vitrin**, 180 cm,
edzett üveg, zár
-  **Vitrina para expositor de parede**, A 180 cm,
vidro temperado, fechadura
-  **Εκθετήριο τοίχου βιτρίνα**, H 180 cm,
ενισχυμένο γυαλί, κλειδαριά

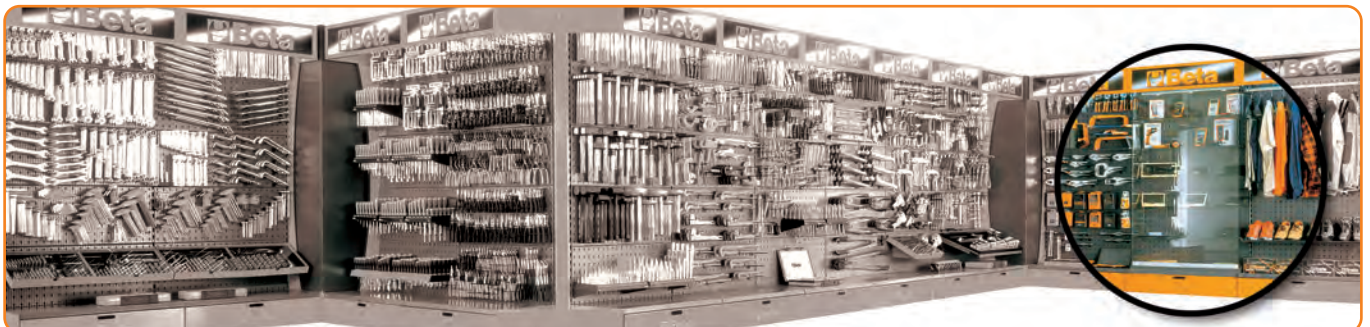
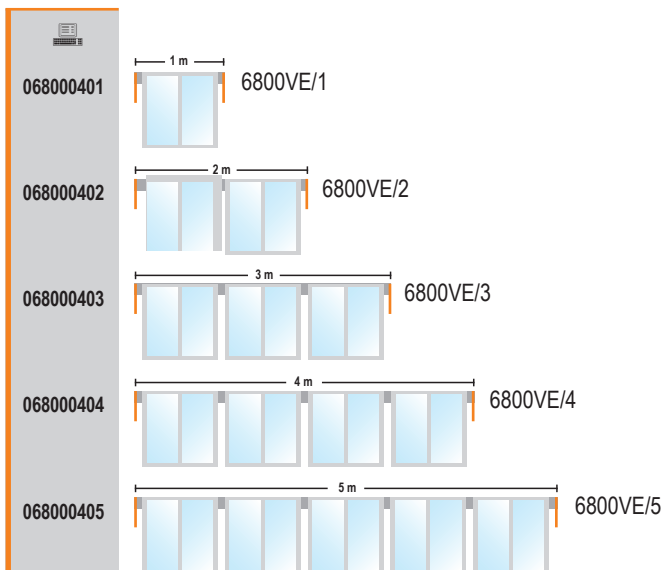
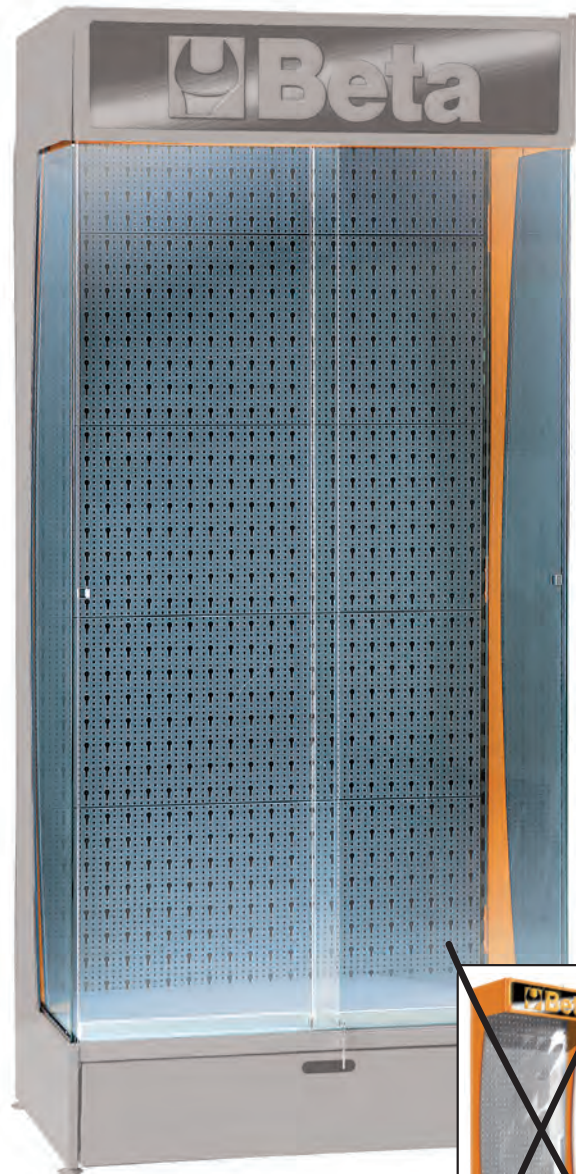











6800 AE

068000145

-  Angolo esterno
-  Outer corner
-  Angle externe
-  Ángulo externo
-  Außenwinkel
-  Buiten hoekwand, oranje
-  Narożnik zewnętrzny
-  Külső sarokelem
-  Canto exterior
-  Εξωτερική γωνία











6800 AI

068000140

-  Angolo interno
-  Inner corner
-  Angle interne
-  Ángulo interno
-  Innenwinkel
-  Binne hoekwand, zwart
-  Narożnik wewnętrzny wypełniający
-  Belső sarokelem
-  Canto interior
-  Εσωτερική γωνία

6800 AD/P

068000143

-  Angolo obliquo
-  Oblique corner
-  Angle oblique
-  Ángulo oblicuo
-  Schrägwinkel
-  Schuine wand
-  Narożnik wewnętrzny wystawienniczy
-  Átlós sarokelem
-  Canto oblíquo
-  Λοξή γωνία

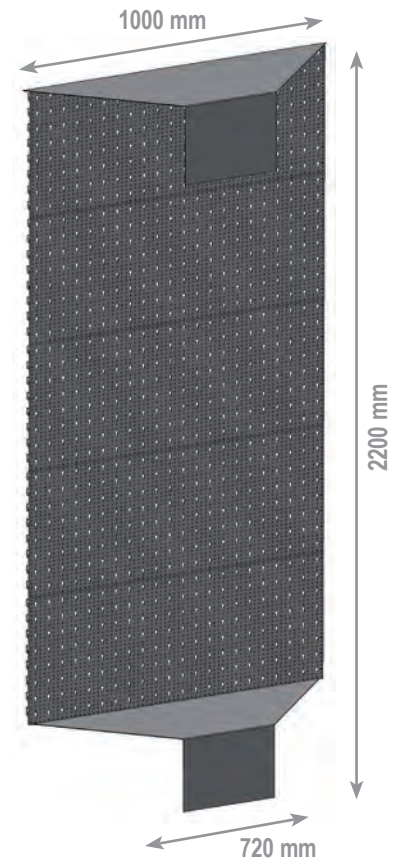
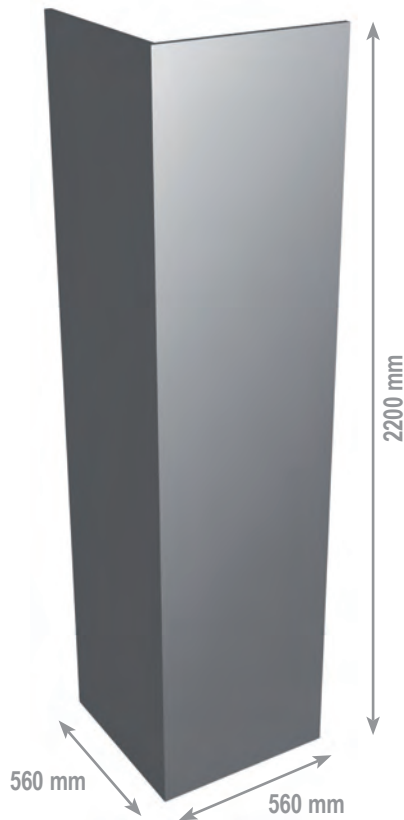
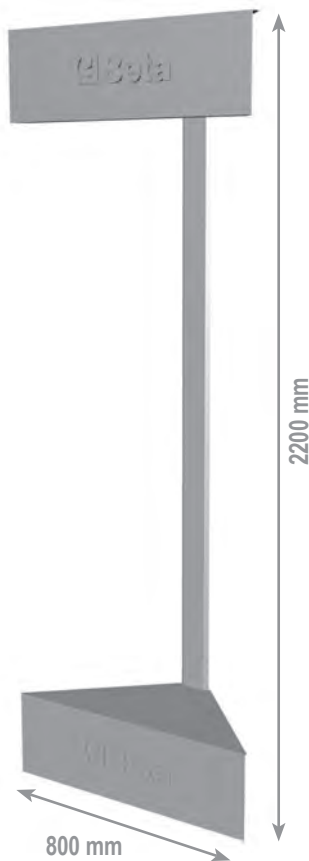

6800 BA

068000130

-  Barra abbigliamento
-  Clothes bar
-  Barre porte-vêtements
-  Barra para prendas de vestuario
-  Kleiderstange
-  Kleding drager
-  Wieszak na odzież
-  Vállfartató rúd
-  Barra para roupa
-  Κρεμάστρα ρούχων

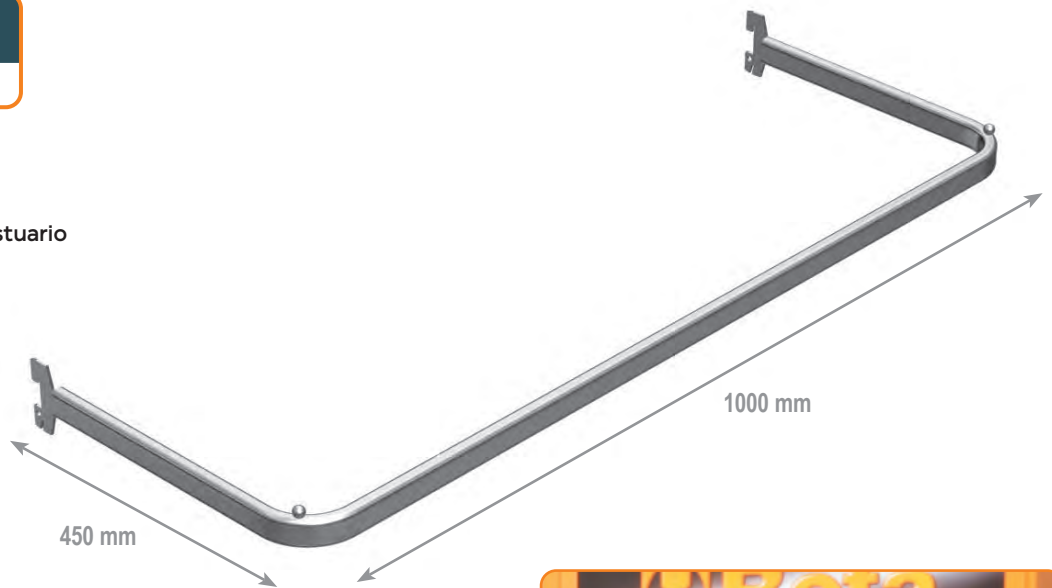

6800 RS





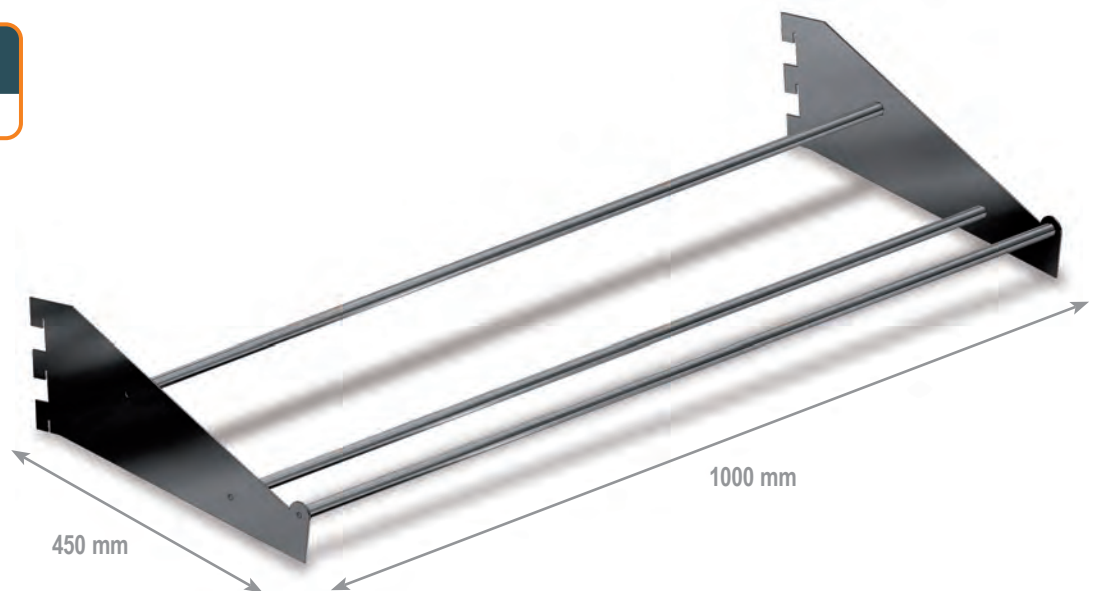





068000135

-  Rastrelliera scarpe
-  Shoe rack
-  Porte-chaussures
-  Estantería para calzado
-  Schuhgestell
-  Schoenen rek
-  Półka na obuwie
-  Cipőtartó
-  Prateleira para sapatos
-  Ράφι παπουτσιών



6800 RP/100





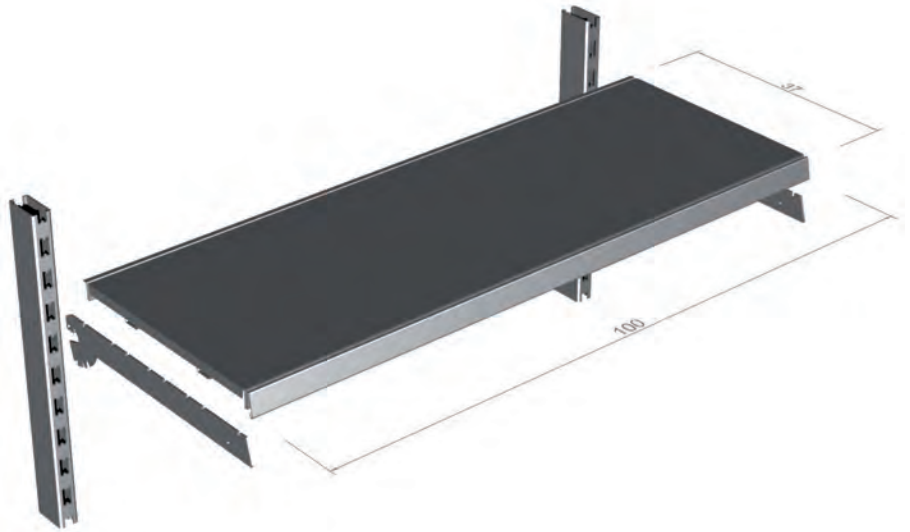





 068000150

-  Ripiano parete: profondità 37 cm
-  Wall shelf: depth 37 cm
-  Étagère murale: profondeur 37 cm
-  Estante de pared: profundidad 37 cm
-  Wandbord: Tiefe 37 cm
-  Wand plank: diepte 37 cm
-  Półka wisząca: głębokość 37 cm
-  Fali: polc 37 cm
-  Prateleira de parede: profundidade 37 cm
-  Ράφι τοίχου: βάθος 37 cm



6800 GR/37

 068000159

-  Gancio ripiano: profondità 37 cm
-  Shelf hook: depth 37 cm
-  Crochet étagère: profondeur 37 cm
-  Gancho estante: profundidad 37 cm
-  Haken für Bord: Tiefe 37 cm
-  Wand haak: diepte 37 cm
-  Wspornik: półki 37 cm
-  Ruhaállvány: 37 cm
-  Suporte prateleira: profundidade 37 cm
-  Γάντζος ραφιού: βάθος 37 cm

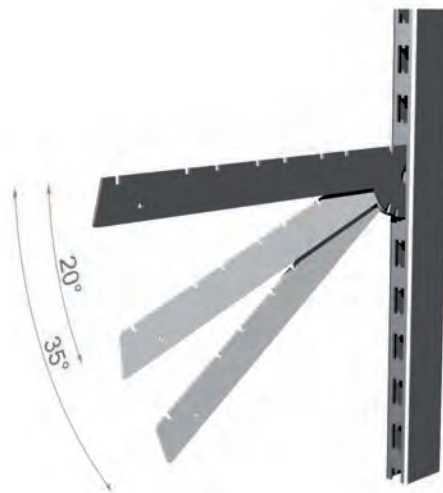

=

1x



+

2x













 068000150

 068000159



6800 PM

-  Prolunga montante
-  Upright extension
-  Rallonge montant
-  Elemento de prolongación montante
-  Ständerverlängerung
-  Frame verlenging
-  Profil przedłużający
-  Faliállvány hosszabbító
-  Extensão de coluna
-  Κατακόρυφη προέκταση



h 400 mm

1 m

1 + 2

068000108 068000171

2 m

2 + 3

068000108 068000171

N m

N + N+1

068000108 068000171

6800 PM/40
068000171

800 mm

h 800 mm

1 m

2 + 2

068000108 068000172

2 m

4 + 3

068000108 068000172

N m

2N + 2N+1

068000108 068000172

6800 PM/80
068000172

6800 FR

068000173

-  Frontalino soprainsegna
-  Sign front
-  Façade couvre-enseigne
-  Carátula sobre-letrero
-  Schild-Stirnteil
-  Basis logo
-  Osłona dodatkowa szyldu
-  Faliállvány siltes homlokrésszel
-  Painel frontal
-  Μηροσπινή πινακίδα

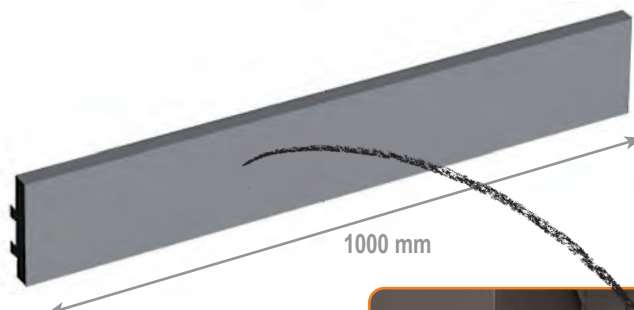

1000 mm



6800 L/MT-1

068000122

-  Insegna luminosa espositore
-  Luminous sign
-  Enseigne lumineuse
-  Letrero luminoso
-  Leuchtschild
-  Lichtbak
-  Szyld z logo podświetlany
-  Világítótest
-  Sinal luminoso
-  Φωτεινή επιγραφή



× 6888VE...



× 6800PM













× 6800AE-6800AI-6800AD/P



6800 P/AI

068000174

-  Prolunga angolo interno 80 cm
-  Inner corner extension 80 cm
-  Rallonge angle interne 80 cm
-  Elemento de prolongación ángulo interno 80 cm
-  Innenwinkelverlängerung 80 cm
-  Verlenging hoekwand 80 cm
-  Przedłużenie narożnika wewnętrznego 80 cm
-  Belső sarokelem hosszabbító 80 cm
-  Extensão canto interior 80 cm
-  Προέκταση εσωτερικής γωνίας 80 cm

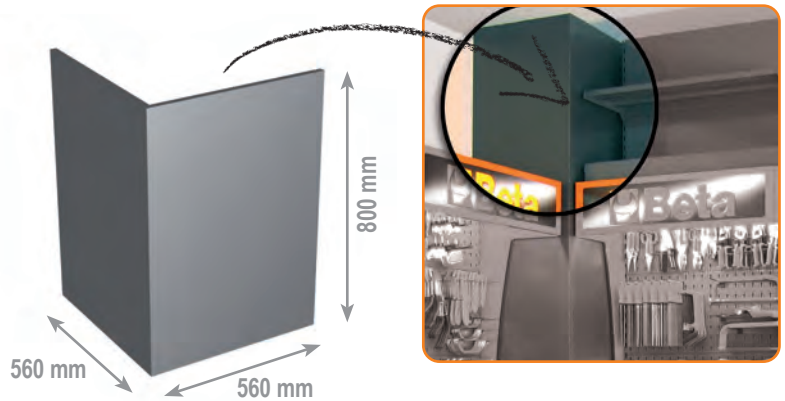

6800 FO/100

068000108

-  Pannello parete pieno
-  Smooth wall panel
-  Panneau mural plein
-  Panel de pared lleno
-  Durchgehendes Wandpaneel
-  Glad wand paneel
-  Panel ścienny gładki
-  Hátsó panel
-  Painel de parede liso
-  Πάνελ

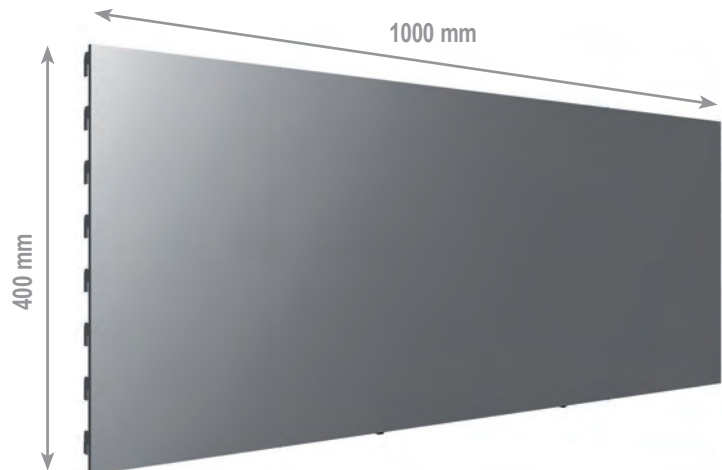

6800 PF/100

068000101

-  Pannello parete pieno
-  Smooth wall panel
-  Panneau mural plein
-  Panel de pared lleno
-  Durchgehendes Wandpaneel
-  Glad wand paneel
-  Panel ścienny gładki
-  Hátsó panel
-  Painel de parede liso
-  Πάνελ

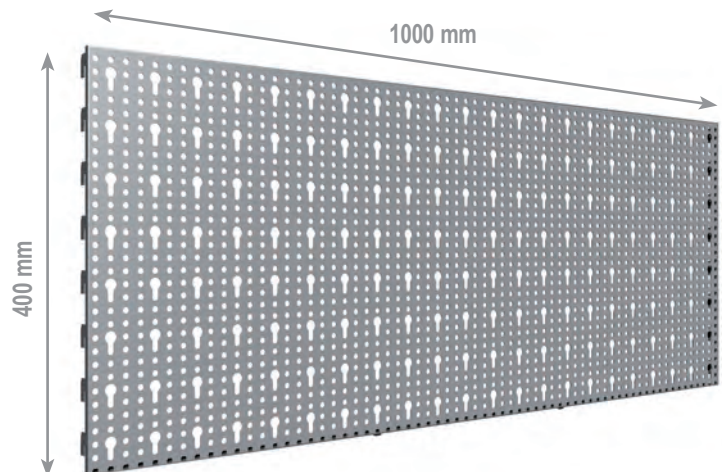

6800 CB/100





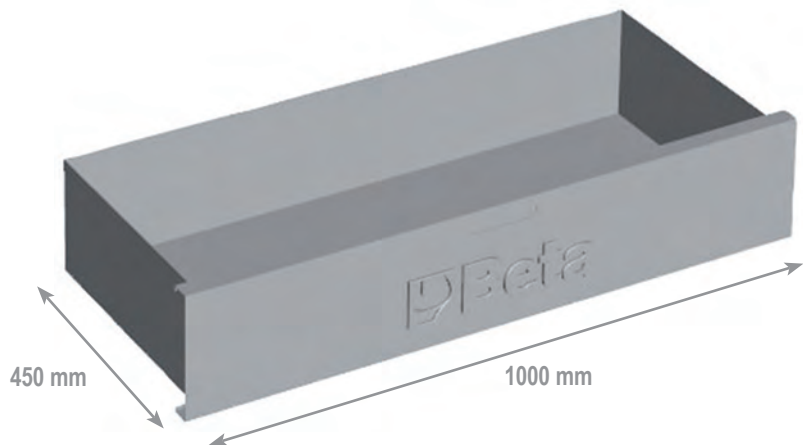





068000104

-  Cassetto base
-  Base drawer
-  Tiroir de base
-  Cajón de base
-  Basisschublade
-  Vloer lade
-  Szuflada do podstawy regału
-  Basis fiók
-  Gaveta base
-  Συρτάρι βάσης



6800 FB/100

068000109

-  Frontalino base
-  Base front
-  Façade base
-  Carátula de base
-  Basis-Stirnteil
-  Vloer panel
-  Osłona przednia podstawy regału
-  Basis-homlokfal
-  Base frontal
-  Μηροστινή βάση

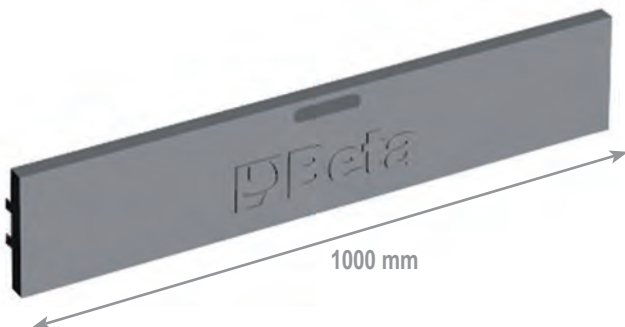







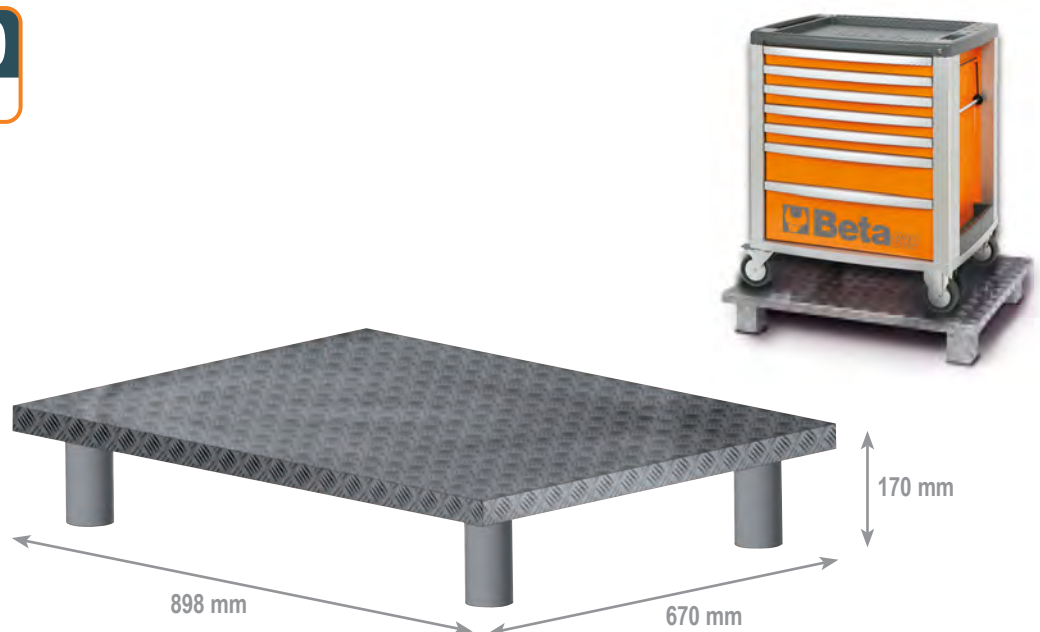

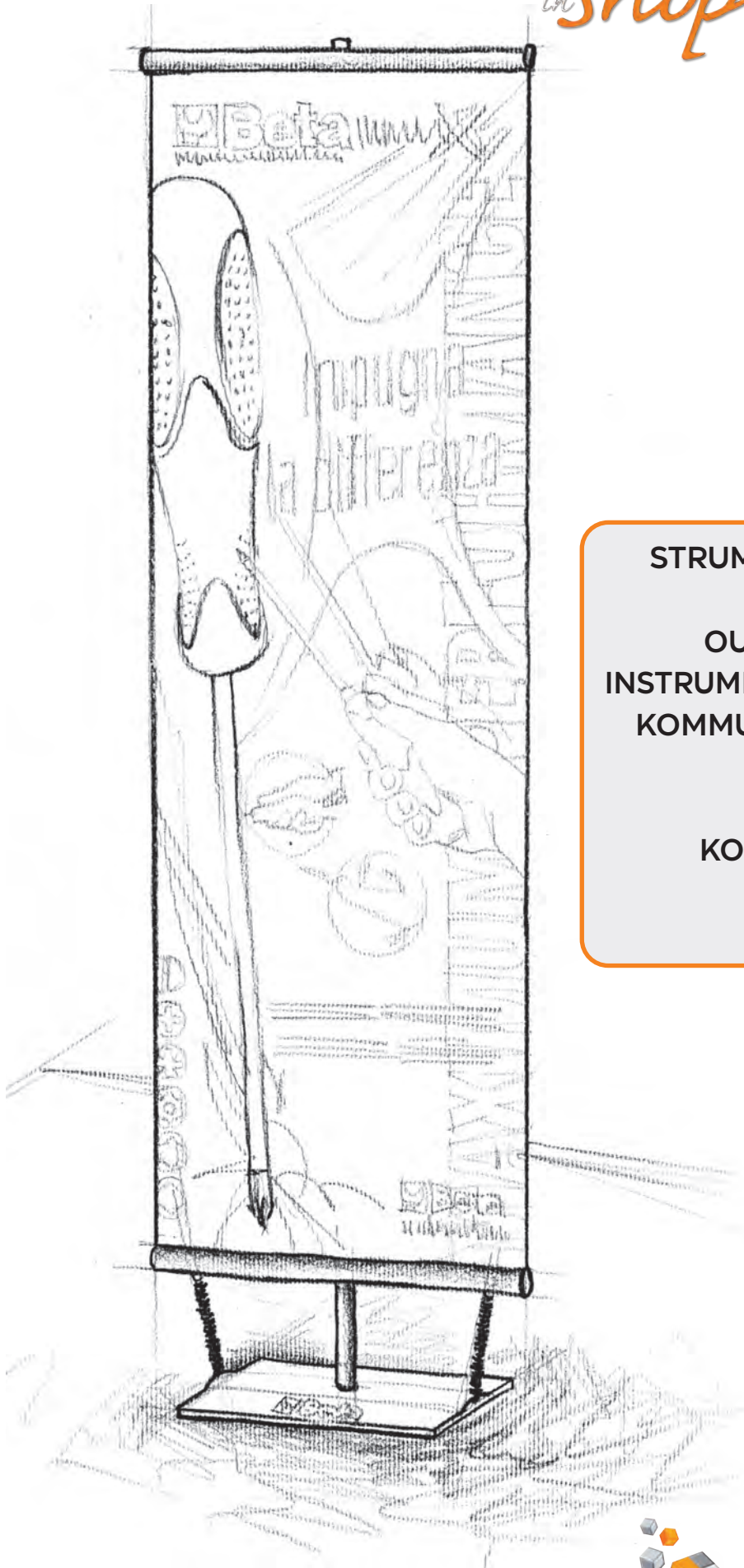

6800 FB/100

068000137

-  Pedana
-  Footboard
-  Estrades
-  Plataformas
-  Fußbretter
-  Voettrede
-  Platformy ekspozycyjnej
-  Lábazat
-  Painel inferior
-  Πόδια









- STRUMENTI DI COMUNICAZIONE 
- COMMUNICATION 
- OUTILS DE COMMUNICATION 
- INSTRUMENTOS DE COMUNICACIÓN 
- KOMMUNIKATIONSINSTRUMENTE 
- COMMUNICATIE MEDIUMS 
- ŚRODKI REKLAMOWE 
- KOMMUNIKÁCIÓS ESZKÖZÖK 
- MEIOS DE COMUNICAÇÃO 
- ΜΕΣΑ ΠΡΟΒΟΛΗΣ 



7120D











071200900

-  Piantana portavolantini
-  Leaflet Display Stand
-  Porte-brochures
-  Portafolletos de pie
-  Prospektständer



9565K

095650500

-  Tavolo 9565T con due sedute 9565S
-  Drum table with two seats
-  Table fût avec deux assises
-  Barril mesa con dos asientos
-  Tonnentisch mit zwei Sitzplätzen
-  Vat tafel met twee krukjes
-  Stół z dwoma taboretami
-  Hordóasztal két székkal
-  Mesa bidão com dois assentos
-  Τραπέζι και δύο θέσεις



9565T
h 95 → 108 cm - Ø 70 cm

9565S
h 60 cm - Ø 38 cm



A1



A2











A3



A4



-  **Pannelli grafici**
Misure personalizzate
-  **Graphic panels**
Customized dimensions
-  **Panneaux graphique**
Dimensions sur mesure
-  **Paneles gráficos**
Medidas personalizadas
-  **Grafik-Paneele**
Personalisierte Abmessungen

-  **Panelen met opdruk**
Afmetingen op aanvraag
-  **Banery z grafiką reklamową.**
Możliwość dostosowania wymiarów do potrzeb użytkownika
-  **Grafikus –panel**
Feliratozott
-  **Painéis gráficos**
Dimensões personalizadas
-  **Γραφιστικές πινακίδες**
Διαστάσεις κατά παραγγελία



B



C



D1



D2



E





Beta Collection



È una linea di prodotti esclusivi pensati e realizzati come espressione del carattere Beta che comprende creazioni originali di altissima qualità: attrezzature sportive, abbigliamento tecnico e una molteplicità di oggettistica personalizzata. Ideali per dar vita ad iniziative promozionali, e per trascorrere momenti di svago.



A range of exclusive products designed and developed to epitomize Beta's character, it comprises original, first-rate items: sports equipment, technical clothing and a variety of tailored objects. An ideal medium for promotional actions, a must for recreational moments.



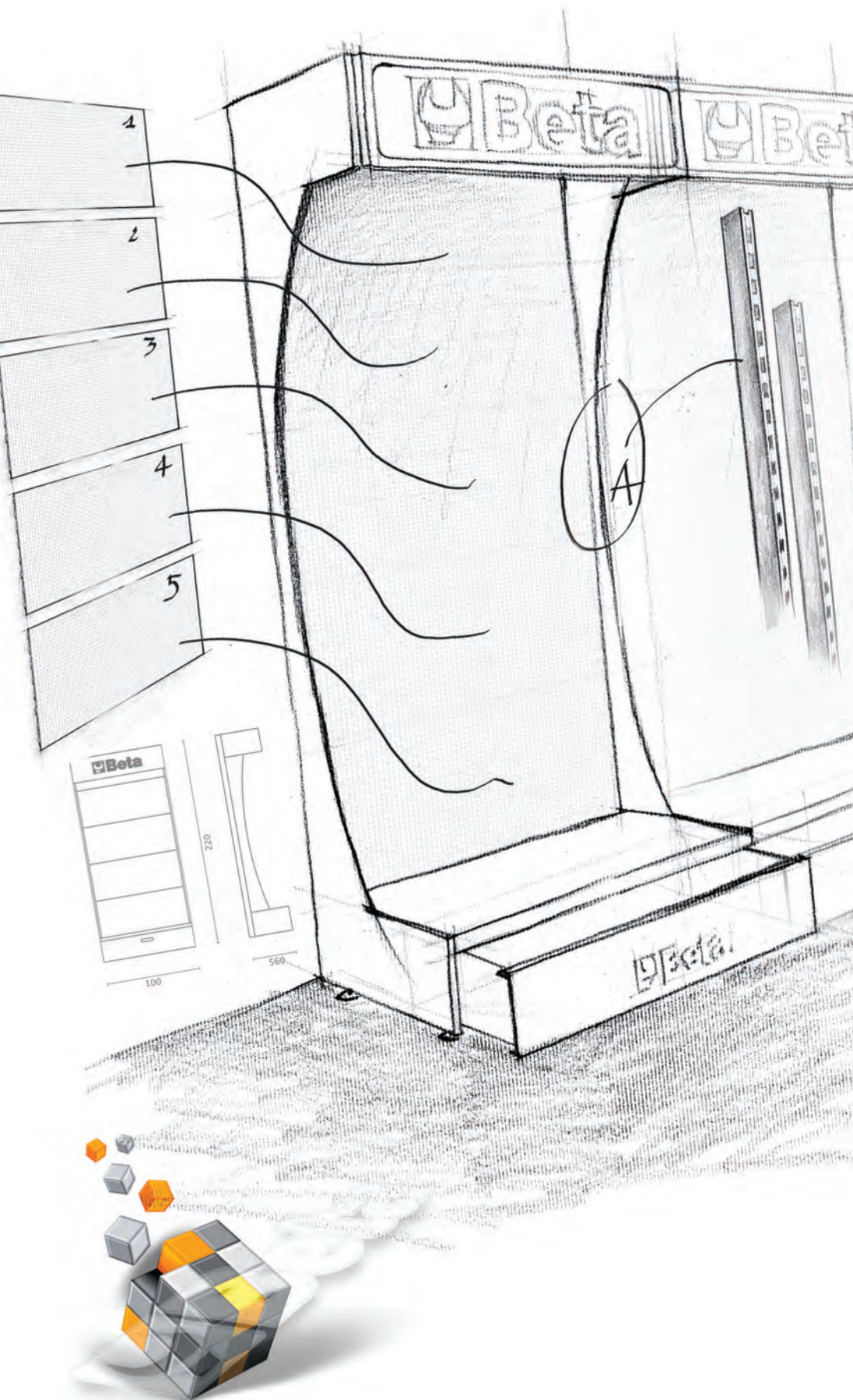

Le immagini riprodotte sono indicative.

Beta Utensili S.p.A. si riserva il diritto di apportare aggiornamenti e migliorie alla propria gamma produttiva senza preavviso.



The pictures are given by way of example.

Beta Utensili reserve the right to update and enhance their product range without notice.



Les renseignements et photos figurant dans ce chapitre sont donnés à titre indicatifs et n'ont aucune valeur contractuelle.

Beta Utensili se réserve le droit de mettre à jour ou d'accroître sa gamme de produits sans préavis, et sans obligation d'effectuer les modifications sur les modèles vendus antérieurement.



Las fotos que se reproducen sirven tan sólo de indicación.

Beta Utensili se reserva el derecho de aportar actualizaciones y mejoras a su gama de productos sin previo aviso.



Die dargestellten Bilder dienen zur Orientierung.

Die Firma Beta Utensili behält sich das Recht vor, ihre Produktpalette ohne Vorankündigung anzupassen oder zu verbessern.



De afbeeldingen dienen uitsluitend als voorbeeld.

Beta utensili behoudt zich het recht voor de producten te wijzigen en te verbeteren zonder voorafgaand bericht.



Zamieszczone zdjęcia narzędzi należy traktować jako przykładowe.

Beta zastrzega sobie prawo do wprowadzania zmian oraz udoskonaleni w swoich produktach bez powiadomienia.



A nyomtatott képek tájékoztató jellegűek. Beta Utensili cég fenntartja magának azt a jogot, hogy áruválasztékán előzetes bejelentés nélkül változtatást hajtson végre.



Todas as informações e imagens que aparecem neste catálogo são meramente indicativas e sem qualquer valor contratual.

A Beta Utensili reserva-se ao direito de alterar ou actualizar a sua gama de produtos sem aviso prévio, e sem obrigação de efectuar qualquer modificação sobre os modelos vendidos anteriormente.



Οι απεικονίσεις παρατίθενται σαν παράδειγμα.

Η Beta Utensili διατηρεί το δικαίωμα να τροποποιεί και να βελτιώνει την σειρά προϊόντων της χώρας χωρίς άλλη ειδοποίηση.

 **Beta**
SHOP
in Shop



099804468

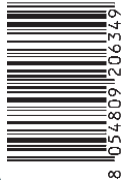

 **Beta**

Beta Utensili S.p.A.
Via A. Volta, 18
20845 Sovico (MB) - Italy
www.beta-tools.com